

# AVR 147 Audio/Video Receiver

## OWNER'S MANUAL

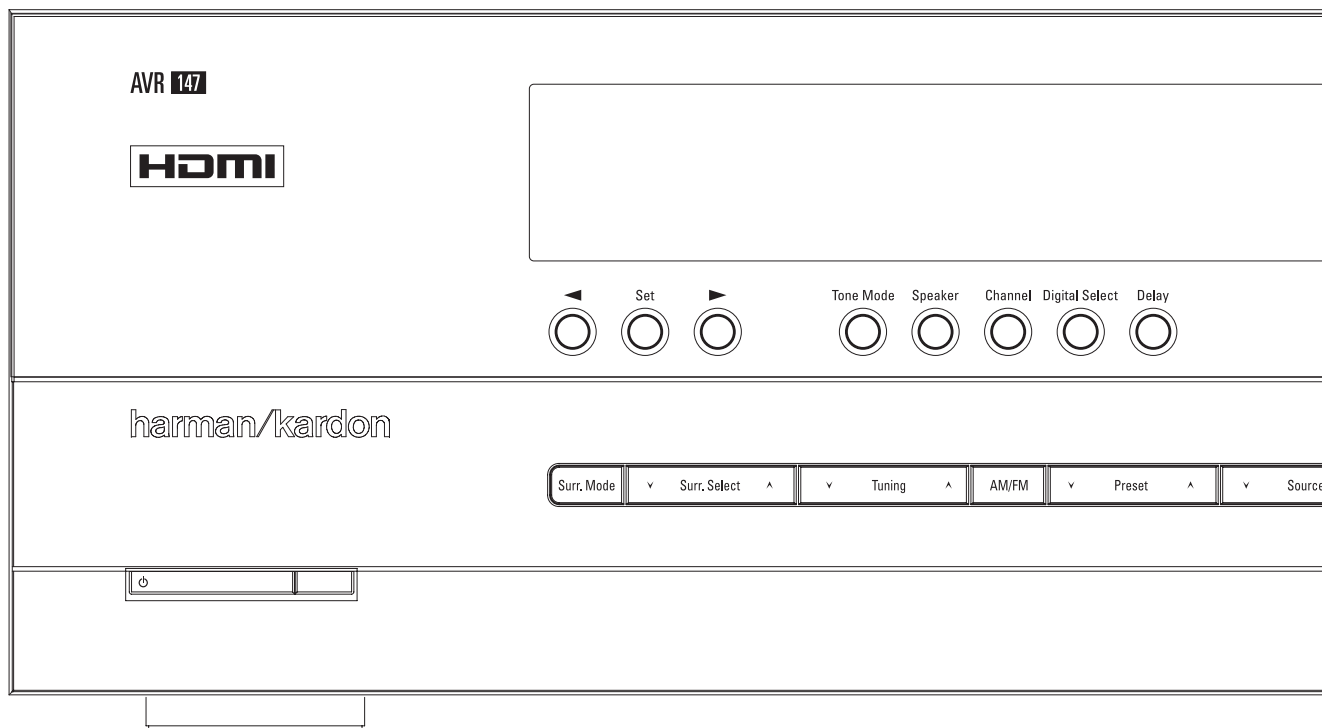

harman/kardon®

# Table of Contents

- 3 Introduction
- 4 Safety Information
- 4 Unpacking
- 5 Front Panel Controls
- 7 Rear Panel Connections
- 9 Main Remote Control Functions
- 13 Installation and Connections
  - 13 Audio Connections
  - 13 Video Connections
  - 14 HDMI Connections
  - 14 SCART A/V Connections
  - 15 Power Connections
  - 16 Speaker Selection
  - 16 Speaker Placement
- 17 System Configuration
  - 17 First Turn On
  - 17 Using the On-Screen Display
  - 17 System Setup
    - 18 Input Setup
    - 19 Surround Setup
    - 20 Night Mode Settings
    - 20 Configuring the Surround Off (Stereo) Modes
    - 21 Automated Speaker Setup Using EzSet/EQ
    - 23 Manual Setup
      - 23 Speaker Setup
      - 26 Delay Settings
      - 27 Output Level Adjustment
- 30 Operation
  - 30 Surround Mode Chart
  - 32 Basic Operation
  - 32 Source Selection
  - 32 6-Channel Direct Input
  - 32 Controls and Use of Headphones
  - 33 Surround Mode Selection
  - 33 Digital Audio Playback
    - 33 Dolby Digital
    - 33 DTS
    - 34 PCM Audio Playback
    - 34 Selecting a Digital Source
    - 34 Digital Bitstream Indicators
  - 34 Surround mode Types
    - 35 Surround Mode Post Processing
    - 35 PCM Playback Indications
    - 35 Speaker/Channel Indicators
  - 36 Night Mode
  - 37 Tape Recording
  - 37 Using The Bridge <sup>™</sup>Bridge
  - 38 Output Level Adjustment With Source Signals
  - 38 Dim function
  - 38 Memory backup
  - 39 System Setup
    - 39 Front Panel Display Fade
    - 39 Turn-On Volume Level
    - 39 Semi-OSD Settings
    - 40 Full-OSD Time Out Adjustment
    - 40 Default Surround Mode
    - 40 Full-OSD Background Color
  - 41 Tuner Operation
    - 41 Basic Tuner Operation
    - 41 Station Selection
    - 41 Preset Tuning
  - 42 RDS Operation
    - 42 RDS Tuning
    - 42 RDS Display Options
    - 42 Program Search (PTY)
  - 43 Programming the Remote

- 43 Programming the Remote with Codes
  - 43 Direct Code Entry
  - 43 Auto Search Method
  - 43 Code Readout
  - 44 Macro Programming
  - 44 Programmed Device Functions
  - 44 Volume Punch-Through
  - 45 Channel Control Punch-Through
  - 45 Transport Control Punch-Through
  - 45 Resetting the Remote Memory

- 46 Function List
- 48 Troubleshooting Guide
- 48 Processor Reset
- 49 Technical Specifications
- 50 Appendix - Settings Worksheet

## Declaration of Conformity



We, Harman Consumer Group, Inc.  
2, route de Tours  
72500 Château-du-Loir,  
FRANCE

declare in own responsibility, that the product described in this owner's manual is in compliance with technical standards:

EN 55013:2001 + A1:2003  
EN 55020:2002 + A1:2003  
EN 61000-3-2:2000  
EN 61000-3-3:1995 + A1:2001  
EN 60065:2002

Jurjen Amsterdam  
Harman Consumer Group, Inc.  
06/07

### Typographical Conventions

In order to help you use this manual with the remote control, front-panel controls and rear-panel connections, certain conventions have been used.

**EXAMPLE** – (bold type) indicates a specific remote control or front-panel button, or rear-panel connection jack

**EXAMPLE** – (OCR type) indicates a message that is visible on the front-panel information display

**1** – (number in a square) indicates a specific front-panel control

**1** – (number in a circle) indicates a rear-panel connection

**1** – (number in an oval) indicates a button or indicator on the remote

The appearance of the text or cursor for your receiver's on-screen menus may vary slightly from the illustrations in this manual. Whether the text appears in all uppercase or upper- and lowercase characters, performance and operation remain the same.

## Introduction

### Thank you for choosing Harman Kardon!

With the purchase of a Harman Kardon AVR 147 you are about to begin many years of listening enjoyment. Designed to provide all the excitement and detail of movie soundtracks and every nuance of musical selections, the AVR is truly a multichannel receiver for the new millennium. In addition to the traditional 5.1 digital decoding modes such as Dolby Digital and DTS, it offers the latest advancements in surround technology such as Dolby Pro Logic II, the full suite of DTS modes, DTS Neo:6 and the latest 5.1 channel versions of Harman's own Logic 7 technology.

The AVR has been engineered so that it is easy to take advantage of all the power of its digital technology. On-screen menus, fully color coded connection jacks and terminals make installation fast and simple. However, to obtain the maximum enjoyment from your new receiver, we urge you to read this manual. A few minutes spent learning the functions of the various controls will enable you to take advantage of all the power the AVR is able to deliver.

If you have any questions about this product, its installation or its operation, please contact your retailer or custom installer. They are your best local sources of information.

### Description and Features

The AVR is among the most versatile and multi-featured A/V receivers available, incorporating a wide range of listening options. In addition to Dolby Digital and DTS decoding for digital sources, a broad choice of surround modes for Matrix surround-encoded or Stereo recordings are available for use with sources such as CD, VCR, TV broadcasts and the AVR's own FM/AM tuner. Along with Dolby Digital, Dolby Pro Logic II, DTS Neo:6, DTS 96/24, Dolby 3 Stereo, 5 Channel Stereo and Hall and Theater modes, the AVR offers Harman International's exclusive Logic 7 process in 5.1 versions to create a wider, more enveloping field environment and more defined fly-overs and pans.

Dolby Virtual Speaker is available to create enveloping sound fields from front left and right speakers, and the latest Dolby Headphone circuitry creates an amazing sense of openness with headphones.

In addition to providing a wide range of listening options, the AVR is easy to configure so that it provides the best results with your speakers and specific listening-room environment.

A Stereo-Direct mode bypasses the digital processor to preserve all of the subtleties of older analog, two-channel materials, while bass management, available in the surround and Stereo-Digital modes, improves your ability to tailor the sound to suit your room acoustics or taste.

The AVR 147 takes the "video" part of its name seriously. Along with two HDMI inputs and two 100MHz analog component video inputs, the

AVR 147 provides A/V sync delay so that the lip sync errors – commonly seen when digital video processing is used in a source, program or video display – are eliminated. For the ultimate in flexibility, the AVR features connections for four video devices, all with both composite and S-Video inputs. Two additional audio inputs are available, and a total of six digital inputs and two outputs make the AVR 147 capable of handling all the latest digital audio sources.

For compatibility with the latest HDTV video sources and progressive scan DVD players, the AVR also features wide-bandwidth, low-crosstalk component video switching.

Coax and optical digital outputs are available for direct connection to digital recorders. A video recording output and a color-coded eight-channel input make the AVR 147 virtually future-proof, with everything needed to accommodate tomorrow's new formats right on board.

An important addition to the AVR 147's impressive list of features is EzSet/EQ™, which automates the configuration process to make it quicker, easier and more precise. Using the special microphone supplied with the unit, EzSet/EQ takes the guesswork out of entering speaker "size" and crossover information, delay times for all channels and output levels. In addition to the configuration settings, EzSet/EQ also includes room equalization so that the signals sent to each speaker are tailored to provide accurate sonic quality with your specific combination of speaker type, room size and other factors that influence room acoustics. With EzSet/EQ, your system is custom-configured in a few minutes with accuracy that previously required expensive and hard-to-use test equipment.

In tandem with EzSet/EQ, the AVR 147 includes a full set of manual configuration settings for those who wish to custom-trim their system even further. A Triple Crossover bass management system makes it possible to enter different crossover settings for each speaker group.

Until now, Harman Kardon AVRs have been able to accommodate almost any source device equipped with line-level analog, optical digital or coaxial digital outputs, including most digital media players. With one simple connection between the AVR 147 and the optional Harman Kardon™ Bridge™, you are able to listen to materials stored on your compatible Apple® iPod®\*\*. Your AVR's system remote control has been preprogrammed with control codes that enable you to select tracks for playback and navigate many of your iPod's functions, even from across the room. The Bridge™ will even let you charge your iPod.

The AVR 147's powerful amplifier uses traditional Harman Kardon high-current design technologies to meet the wide dynamic range of any program selection.

Harman Kardon invented the high-fidelity receiver more than fifty years ago. With state-of-the-art circuitry and time-honored circuit designs, the AVR 147 is the perfect combination of the latest in digital audio technology, a quiet yet powerful analog amplifier in an elegant, easy-to-use package.

- **Dolby\* Digital, Dolby Digital and Dolby Pro Logic\* II Decoding, and the full suite of DTS® modes, including DTS Neo:6®**
- **Five channels of high-current amplification**
- **Harman Kardon's exclusive Logic 7® processing, along with a choice of Dolby Virtual Speaker processing for use when only two speakers are available**
- **Dolby Headphone to create spacious, open sound fields when using headphones**
- **Harman Kardon's advanced EzSet/EQ™ automatically configures speaker settings and sets room equalization for quick, easy and accurate system setup**
- **Two HDMI™ 1.1 and three assignable high-bandwidth analog component inputs for compatibility with the latest high-definition video sources**
- **Stereo-Direct Mode for Two-Channel Sources Bypasses DSP Processing to Preserve the Integrity of Analog Materials**
- **Stereo-Digital Mode for Programmable Bass Management of Low Frequencies Between Main Speakers and Subwoofer**
- **Front panel analog A/V inputs**
- **Front panel digital inputs for easy connection to portable digital devices and the latest video game consoles**
- **Connects to Harman Kardon's™ Bridge™ (optional) for charging, playback and control of a compatible Apple® iPod® device**
- **Input titling for all input sources (except tuner)**
- **Multiple digital inputs and outputs**
- **On-screen menu and display system with choice of blue or black background screen**
- **A/V Sync delay adjustable for each input delivers perfect lip sync with digital programs or video displays**
- **6-Channel Direct Input for Use with Future Audio Formats**
- **Extensive bass management options, including three separate crossover groupings**
- **Main Remote with Internal Codes**

\*\*Compatible with all iPod models equipped with a dock connector, including third-generation "Click Wheel" models and newer. Not compatible with iPod shuffle models. Although iPod photo models are compatible, images stored on the iPod may not be viewed.

# Safety Information

## Important Safety Information

### READ THIS BEFORE OPERATING YOUR UNIT

Do not install this equipment in a confined space such as a case or similar – away from direct sunlight, heat sources, vibration, dust, moisture, and/or cold. Avoid installing this unit where foreign object may fall onto this unit and/or this unit may be exposed to liquid dripping or splashing. On the top of this unit, do not place:

- Burning objects (i.e. candles), as they may cause fire, damage to this unit, and/or personal injury.
- Containers with liquid in them, as they may fall and liquid may cause electrical shock to the user and/or damage to this unit.

Do not cover this unit with a newspaper, tablecloth, curtain, etc. in order not to obstruct heat radiation. If the temperature inside this unit rises, it may cause fire, damage to this unit, and/or personal injury.

Install this unit near the AC outlet and where the AC power plug can be reached easily.

This unit is not disconnected from the AC power source as long as it is connected to the wall outlet, even if this unit itself is turned off. This state is called the standby mode. In this state, this unit is designed to consume a very small quantity of power.

### WARNING. TO REDUCE THE RISK OF FIRE OR ELECTRIC SHOCK, DO NOT EXPOSE THIS APPLIANCE TO RAIN OR MOISTURE.

#### Verify Line Voltage Before Use

Your AVR has been designed for use with 220-240-Volt AC current. Connection to a line voltage other than that for which it is intended can create a safety and fire hazard and may damage the unit. If you have any questions about the voltage requirements for your specific model, or about the line voltage in your area, contact your dealer before plugging the unit into a wall outlet.

#### Do Not Use Extension Cords

To avoid safety hazards, use only the power cord attached to your unit. We do not recommend that extension cords be used with this product. As with all electrical devices, do not run power cords under rugs or carpets or place heavy objects on them. Damaged power cords should be replaced immediately by an authorized service depot with a cord meeting factory specifications.

#### Handle the AC Power Cord Gently

When disconnecting the power cord from an AC outlet, always pull the plug, never pull the cord. If you do not intend to use the unit for any considerable length of time, disconnect the plug from the AC outlet.

#### Do Not Open the Cabinet

There are no user-serviceable components inside this product. Opening the cabinet may present a shock hazard, and any modification to the product will void your guarantee. If water or any metal object such as a paper clip, wire or a staple accidentally falls inside the unit, disconnect it from the AC power source immediately, and consult an authorized service station.

#### Installation Location

- To assure proper operation and to avoid the potential for safety hazards, place the unit on a firm and level surface. When placing the unit on a shelf, be certain that the shelf and any mounting hardware can support the weight of the product.
- Make certain that proper space is provided both above and below the unit for ventilation. If this product will be installed in a cabinet or other enclosed area, make certain that there is sufficient air movement within the cabinet. Under some circumstances a fan may be required.
- Do not place the unit directly on a carpeted surface.
- Avoid installation in extremely hot or cold locations, or an area that is exposed to direct sunlight or heating equipment.
- Avoid moist or humid locations.

- Do not obstruct the ventilation slots on the top of the unit, or place objects directly over them.
- Due to the weight of the AVR 147 and the heat generated by the amplifiers, there is the remote possibility that the rubber padding on the bottom of the unit's feet may leave marks on certain wood or veneer materials. Use caution when placing the unit on soft woods or other materials that may be damaged by heat or heavy objects. Some surface finishes may be particularly sensitive to absorbing such marks due to a variety of factors beyond Harman Kardon's control, including the nature of the finish, cleaning materials used, and normal heat and vibration caused by the use of the product, or other factors. We recommend that caution be exercised in choosing an installation location for the component and in normal maintenance practices, as your warranty will not cover this type of damage to furniture.

#### Cleaning

When the unit gets dirty, wipe it with a clean, soft, dry cloth. If necessary, wipe it with a soft cloth dampened with mild soapy water, then a fresh cloth with clean water. Wipe dry immediately with a dry cloth. NEVER use benzene, aerosol cleaners, thinner, alcohol or any other volatile cleaning agent. Do not use abrasive cleaners, as they may damage the finish of metal parts. Avoid spraying insecticide near the unit.

#### Moving the Unit

Before moving the unit, be certain to disconnect any interconnection cords with other components, and make certain that you disconnect the unit from the AC outlet.

#### Unpacking

The carton and shipping materials used to protect your new receiver during shipment were specially designed to cushion it from shock and vibration. We suggest that you save the carton and packing materials for use in shipping if you move, or should the unit ever need repair.

To minimize the size of the carton in storage, you may wish to flatten it. This is done by carefully slitting the tape seams on the bottom and collapsing the carton. Other cardboard inserts may be stored in the same manner. Packing materials that cannot be collapsed should be saved along with the carton in a plastic bag.

If you do not wish to save the packaging materials, please note that the carton and other sections of the shipping protection are recyclable. Please respect the environment and discard those materials at a local recycling center.

It is important that you remove the protective plastic film from the front-panel lens. Leaving the film in place will affect the performance of your remote control.

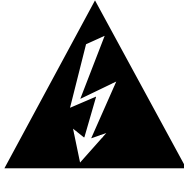

**CAUTION**  
RISK OF ELECTRIC SHOCK  
DO NOT OPEN



**CAUTION: TO REDUCE THE RISK OF ELECTRIC SHOCK, DO NOT REMOVE COVER (OR BACK). NO USER-SERVICEABLE PARTS INSIDE. REFER SERVICING TO QUALIFIED SERVICE PERSONNEL.**



The lightning flash with arrowhead symbol, within an equilateral triangle, is intended to alert the user to the presence of uninsulated "dangerous voltage" within the product's enclosure that may be of sufficient magnitude to constitute a risk of electric shock to persons.



The exclamation point within an equilateral triangle is intended to alert the user to the presence of important operating and maintenance (servicing) instructions in the literature accompanying the appliance.

**WARNING: TO REDUCE THE RISK OF FIRE OR ELECTRIC SHOCK, DO NOT EXPOSE THIS APPLIANCE TO RAIN OR MOISTURE.**

# Front Panel Controls

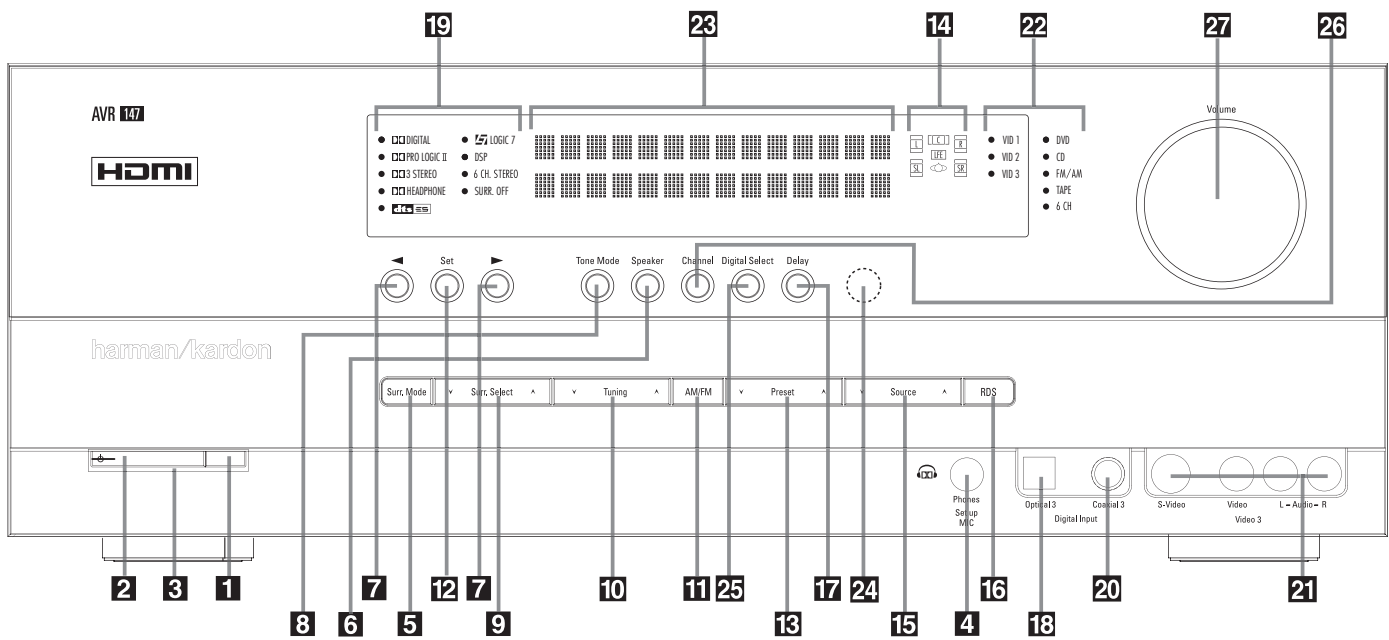

- 1** Main Power Switch
- 2** System Power Control
- 3** Power Indicator
- 4** Headphone Jack
- 5** Surround Mode Group Selector
- 6** Speaker Select Button
- 7** Selector Buttons
- 8** Tone Mode
- 9** Surround Mode Selector
- 10** Tuning

- 11** Tuner Band Selector
- 12** Set Button
- 13** Preset Stations Selector
- 14** Speaker/Channel Input Indicator
- 15** Input Source Selector
- 16** RDS Select Button
- 17** Delay
- 18** Digital Optical 3 Input
- 19** Surround Mode Indicators
- 20** Digital Coax 3 Input

- 21** Video 3 input jacks
- 22** Input Indicators
- 23** Main Information Display
- 24** Remote Sensor Window
- 25** Digital Input Selector
- 26** Channel Select Button
- 27** Volume Control

**1 Main Power Switch:** Press this button to apply power to the AVR. When the switch is pressed in, the unit is placed in a Standby mode, as indicated by the orange LED **3**. This button **MUST** be pressed in to operate the unit. To turn the unit off completely and prevent the use of the remote control, this switch should be pressed until it pops out from the front panel so that the word "OFF" may be read at the top of the switch.

**NOTE:** This switch is normally left in the "ON" position.

**2 System Power Control:** When the **Main Power Switch 1** is "ON," press this button to turn on the AVR; press it again to turn the unit off (to Standby). Note that the **Power Indicator 3** will turn blue when the unit is on.

**3 Power Indicator:** This LED will be illuminated in orange when the unit is in the Standby mode to signal that the unit is ready to be turned on. When the unit is in operation, the indicator will turn blue.

**4 Headphone Jack:** This jack may be used to listen to the AVR's output through a pair of headphones. Be certain that the headphones have a standard 6.3 mm stereo phone plug. Note that the speakers will automatically be turned off when the headphones are connected.

When configuring your system using EzSet/EQ, the calibration microphone should be plugged into this jack **4** using the supplied adaptor that converts the small mini-plug at the end of the microphone's cord to a 1/4" plug.

**5 Surround Mode Group Selector:** Press this button to select the top-level group of surround modes. Each press of the button will select a major mode grouping in the following order:

Dolby Modes → DTS Digital Modes → DSP Modes → Stereo Modes → Logic 7 Modes

Once the button is pressed so that the name of the desired surround mode group appears in the **Main Information Display 23**, press the **Surround Mode Selector 9** to cycle through the individual modes available. For example, press this button to select Dolby modes, and then press the **Surround Mode Selector 9** to choose from the various mode options.

**6 Speaker Select Button:** Press this button to begin the process of selecting the speaker positions that are used in your listening room. (See page 17 for more information on setup and configuration.)



## Front Panel Controls

**7 Selector Buttons:** When you are establishing the AVR's configuration settings, use these buttons to select from the choices available, as shown in the **Main Information Display** 23.

**8 Tone Mode:** Pressing this button enables or disables the Balance, Bass and Treble tone controls. When the button is pressed so that the words **TONE IN** appear in the **Main Information Display** 23, the settings of the **Bass** and **Treble** controls and of the **Balance** control will affect the output signals. When the button is pressed so that the words **TONE OUT** appear in the **Main Information Display** 23, the output signal will be "flat," without any balance, bass or treble alteration.

**9 Surround Mode Selector:** Press this button to select from among the available surround mode options for the mode group selected. The specific modes will vary based on the number of speakers available, the mode group and if the input source is digital or analog. For example, press the **Surround Mode Group Selector** 5 to select a mode grouping such as Dolby or Logic 7, and then press this button to see the mode choices available. For more information on mode selection, see page 30.

**10 Tuning Selector:** Press the left side of the button to tune lower frequency stations and the right side of the button to tune higher frequency stations. When a station with a strong signal is reached, **MANUAL TUNED** or **AUTO TUNED** will appear in the **Main Information Display** 23 (see page 41 for more information on tuning stations).

**11 Tuner Band Selector:** Pressing this button will automatically switch the AVR to the Tuner mode. Pressing it again will switch between the AM and FM frequency bands, holding it pressed for some seconds will switch between stereo and mono receiving and between automatic and manual tuning mode (See page 41 for more information on the tuner).

**12 Set Button:** When making choices during the setup and configuration process, press this button to enter the desired setting as shown in the **Main Information Display** 23 into the AVR's memory.

**13 Preset Stations Selector:** Press this button to scroll up or down through the list of stations that have been entered into the preset memory (See page 41 for more information on tuner programming).

**14 Speaker/Channel Input Indicators:** These indicators are multipurpose, indicating either the speaker type selected for each channel or the incoming data-signal configuration. The left, center, right, right surround and left surround speaker indicators are composed of three boxes, while the subwoofer is a single box. The center box lights when a "Small" speaker is selected, and the two outer boxes light when "Large" speakers are selected. When none of the boxes are lit for the center, surround or subwoofer channels, no speaker has been selected for that position. (See page 23 for more information on configuring speakers.) The letters inside each of the center boxes display active input channels. For standard analog inputs, only the L and R will light, indicating a stereo input. When a digital source is playing, the indicators will light to display the channels begin received at the digital input. When the letters flash, the digital input has been interrupted. (See page 35 for more information on the Channel Indicators).

**15 Input Source Selector:** Press this button to change the input by scrolling through the list of input sources.

**16 RDS Select Button:** Press this button to display the various messages that are part of the RDS data system of the AVR's tuner. (See page 42 for more information on RDS).

**17 Delay:** Press this button to begin the sequence of steps required to enter delay time settings (See page 26 for more information on delay times).

**18 Digital Optical 3 Input:** Connect the optical digital audio output of an audio or video product to this jack. When the Input is not in use, be certain to keep the plastic cap installed to avoid dust contamination that might degrade future performance.

**19 Surround Mode Indicators:** The current selected mode or function will appear as one of these indicators. Note that when the unit is turned on, the entire list of available modes will light briefly, and then revert to normal operation with only the active mode indicator illuminated.

**20 Digital Coax 3 Input:** This jack is normally used for connection to the output of portable digital audio devices, video game consoles or other products that have a coax digital jack.

**21 Video 3 Input Jacks:** These audio/video jacks may be used for temporary connection to video games or portable audio/video products such as camcorders and portable audio players.

**22 Input indicators:** The current selected mode or function will appear as one of these indicators. Note that when the unit is turned on, the entire list of available modes will light briefly, and then revert to normal operation with only the active mode indicator illuminated.

**23 Main Information Display:** This display delivers messages and status indications to help you operate the receiver.

**24 Remote Sensor Window:** The sensor behind this window receives infrared signals from the remote control. Aim the remote at this area and do not block or cover it unless an external remote sensor is installed.

**Note:** When <sup>™</sup>Bridge-/DMP has been selected as the input source, no **Input Indicator** 22 will light. **DMP / THE BRIDGE IS CONNECTED** will scroll across the **Upper Display Line** 23, unless you have retitled the source name, in which case that name will appear. See page 18 for more information on input titling.

**25 Digital Input Selector:** When playing a source that has a digital output, press this button to select between the **Optical** 23 and **Coaxial** 24 digital inputs. (See pages 18 and 33 for more information on digital audio).

**26 Channel Select Button:** Press this button to begin the process of trimming the channel output levels using an external audio source. (For more information on output level trim adjustment, see page 38).

**27 Volume Control:** Turn this knob clockwise to increase the volume, counterclockwise to decrease the volume. If the AVR is muted, adjusting volume control will automatically release the unit from the silenced condition.

# Rear Panel Connections

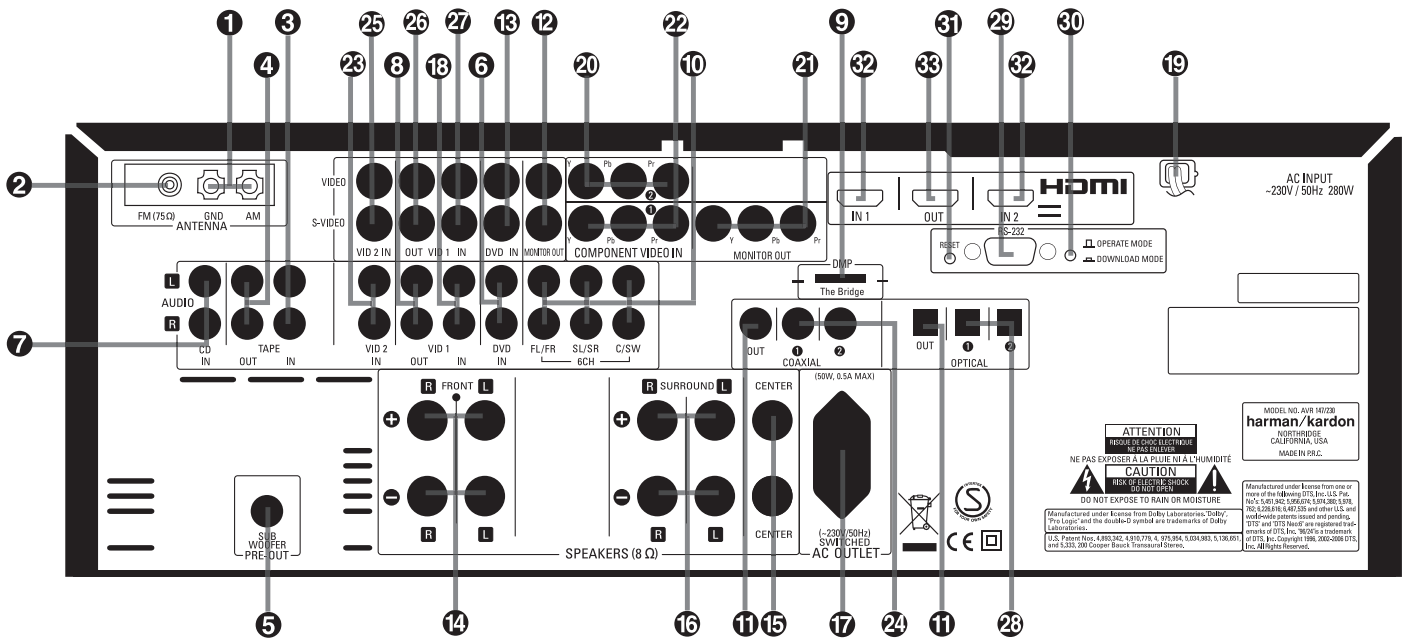

- 1 AM Antenna
- 2 FM Antenna
- 3 Tape Inputs
- 4 Tape Outputs
- 5 Subwoofer Output
- 6 DVD Audio Inputs
- 7 CD Inputs
- 8 Video 1 Audio Outputs
- 9 <sup>The Bridge</sup> DMP Connector
- 10 6-Channel Direct Inputs
- 11 Digital Audio Outputs

- 12 Video Monitor Outputs
- 13 DVD Video Inputs
- 14 Front Speaker Outputs
- 15 Center Speaker Outputs
- 16 Surround Speaker Outputs
- 17 Switched AC Accessory Outlet
- 18 Video 1 Audio Inputs
- 19 AC Power Cord
- 20 Video 2 Component Video Inputs
- 21 Component Video Outputs
- 22 Video 1 Component Video Inputs

- 23 Video 2 Audio Inputs
- 24 Coaxial Digital Inputs
- 25 Video 2 Video Inputs
- 26 Video 1 Video Outputs
- 27 Video 1 Video Inputs
- 28 Optical Digital Inputs
- 29 RS-232 Serial Port
- 30 RS-232 Mode
- 31 RS-232 Reset
- 32 HDMI Inputs
- 33 HDMI Output

**NOTE:** To assist in making the correct connections for multichannel input/output and speaker connections, all connection jacks and terminals have been color coded in conformance with the latest CEA standards as follows:

Front Left:	White
Front Right:	Red
Center:	Green
Surround Left:	Blue
Surround Right:	Gray
Surround Back Left:	Brown
Surround Back Right:	Tan
Subwoofer (LFE):	Purple
Digital Audio:	Orange
Composite Video:	Yellow
Component Video "Y":	Green
Component Video "Pr":	Red
Component Video "Pb":	Blue

**1 AM Antenna:** Connect the AM loop antenna supplied with the receiver to these terminals. If an external AM antenna is used, make connections to the **AM** and **GND** terminals in accordance with the instructions supplied with the antenna.

**2 FM Antenna:** Connect the supplied indoor or an optional external FM antenna to this terminal.

**3 Tape Inputs:** Connect these jacks to the **PLAY/OUT** jacks of an audio recorder.

**4 Tape Outputs:** Connect these jacks to the **RECORD/INPUT** jacks of an audio recorder.

**5 Subwoofer Output:** Connect this jack to the line-level input of a powered subwoofer. If an external subwoofer amplifier is used, connect this jack to the subwoofer amplifier input.

**6 DVD Audio Inputs:** Connect these jacks to the analog audio jacks on a DVD or other audio or video source.

**7 CD Inputs:** Connect these jacks to the analog output of a compact disc player or CD changer or any other audio source.

**8 Video 1 Audio Outputs:** Connect these jacks to the **RECORD/INPUT** audio jacks on a VCR or any other Audio recorder.

**9 <sup>The Bridge</sup> Digital Media Player (DMP) Connector:** With the AVR 147 turned off, connect one end of the optional Harman Kardon <sup>The Bridge</sup> to this proprietary connector, and the other to your compatible Apple iPod. When the Digital Media Player source is selected, you may view your iPod's control and navigation messages on your video display (if one is connected to one of the **Video Monitor Outputs** 12), and in the **Upper and Lower Display Lines** 23. You may navigate the iPod and select tracks for playback using the **▲/▼/◀/▶ Buttons** 14 15 37, the **Set Button** 16 and **Transport Controls** 26 on your AVR remote. See page 37 for more information.

## Rear Panel Connections

**10 6-Channel Direct Inputs:** These jacks are used for connection to source devices such as DVD-Audio or SACD players with discrete analog outputs.

**11 Digital Audio Outputs:** Connect these jacks to the matching digital input connector on a digital recorder such as a CD-R or MiniDisc recorder.

**12 Video Monitor Outputs:** Connect this jack to the composite and/or S-Video input of a TV monitor or video projector to view the on-screen menus and the output of any standard Video or S-Video source selected by the receiver's video switcher.

**13 DVD Video Inputs:** Connect these jacks to the composite or S-Video output jacks on a DVD player or other video source.

**14 Front Speaker Outputs:** Connect these outputs to the matching + or – terminals on your left and right speakers. In conformance with the new CEA color code specification, the White terminal is the positive, or "+" terminal that should be connected to the red (+) terminal on Front Left speaker with the older color coding, while the Red terminal is the positive, or "+" terminal that should be connected to the red (+) terminal on Front Right speaker. Connect the black (–) terminals on the AVR to the black (–) terminals on the speakers. See page 13 for more information on speaker polarity.

**15 Center Speaker Outputs:** Connect these outputs to the matching + and – terminals on your center channel speaker. In conformance with the new CEA color code specification, the Green Terminal is the positive, or "+" terminal that should be connected to the red (+) terminal on speakers with the older color coding. Connect the black (–) terminal on the AVR to the black negative (–) terminal on your speaker. (See page 13 for more information on speaker polarity.)

**16 Surround Speaker Outputs:** Connect these outputs to the matching + and – terminals on your surround channel speakers. In conformance with the new CEA color code specification, the Blue terminal is the positive, or "+" terminal that should be connected to the red (+) terminal on the Surround Left speaker with older color coding, while the Gray terminal should be connected to the red (+) terminal on the Surround Right speaker with the older color coding. Connect the black (–) terminal on the AVR to the matching black negative (–) terminals for each surround speaker. (See page 13 for more information on speaker polarity.)

**17 Switched AC Accessory Outlet:** This outlet may be used to power any device that you wish to have turn on when the AVR is turned on with the **System Power Control** switch **2**.

**Note:** The total power consumption of all devices connected to the accessory outlets should not exceed 50 W from the **Switched Outlet 17**.

**18 Video 1 Audio Inputs:** Connect these jacks to the **PLAY/OUT** audio jacks on a TV or other audio or video source.

**19 AC Power Cord:** Connect the AC plug to an unswitched AC wall outlet.

**20 Video 2 Component Video Inputs:** Connect the Y/Pr/Pb component video outputs of an HDTV Set-top convertor, satellite receiver, or other video source device with component video outputs to these jacks.

**21 Monitor Component Video Outputs:** Connect these outputs to the component video inputs of a video projector or monitor. When a source connected to one of the two **Component Video Inputs 20/22** is selected the signal will be sent to these jacks.

**22 Video 1 Component Video Inputs:** Connect the Y/Pr/Pb component video outputs of a DVD player to these jacks.

**Note:** All component inputs/outputs can be used for RGB signals too, in the same way as described for the Y/Pr/Pb signals, then connected to the jacks with the corresponding color. RGB connection is not possible if the source outputs a separate sync signal (see page 15).

**23 Video 2 Audio Inputs:** Connect these jacks to the **PLAY/OUT** audio jacks on a second VCR or other audio or video source.

**24 Coaxial Digital Inputs:** Connect the coax digital output from a DVD player, HDTV receiver, the output of a compatible computer sound card playing MP3 files or streams, LD player, MD player or CD player to these jacks. The signal may be either a Dolby Digital signal, DTS signal, a 2 channel MPEG 1 signal, or a standard PCM digital source. Do not connect the RF digital output of an LD player to these jacks.

**25 Video 2 Video Inputs:** Connect these jacks to the **PLAY/OUT** composite or S-Video jacks on a second VCR or other video source.

**26 Video 1 Video Outputs:** Connect these jacks to the **RECORD/INPUT** composite or S-Video jack on a VCR.

**27 Video 1 Video Inputs:** Connect these jacks to the **PLAY/OUT** composite or S-Video jacks on a TV or other video source.

**28 Optical Digital Inputs:** Connect the optical digital output from a DVD player, HDTV receiver, the output of a compatible computer sound card playing MP3 files or streams, LD player, MD player or CD player to these jacks. The signal may be either a Dolby Digital signal, a DTS signal, a 2 channel MPEG 1 signal, or a standard PCM digital source.

**29 RS-232 Serial Port:** This specialized connector may be used with your personal computer in case Harman Kardon offers a software upgrade for the receiver at some time in the future.

**30 RS-232 Mode:** Leave this switch popped out in the Operate position unless the AVR 147 is being upgraded.

**31 RS-232 Reset:** This switch is only used during a software upgrade. A standard processor reset is performed by pressing and holding the front-panel Tone button.

**32 HDMI Inputs:** Connect the HDMI output of video sources such as a DVD player, set-top box or HDTV tuner to either of these jacks.

**33 HDMI Output:** Connect this jack to the HDMI input on a compatible HDMI-equipped video display.

**NOTE ON VIDEO CONNECTIONS:** When connecting a video source product such as a VCR, DVD player, satellite receiver, cable set-top box, personal video recorder or video game to the AVR 147, you may use either a composite or S-video connection, but not both.



# Main Remote Control Functions

- 1 Power Off Button
- 2 IR Transmitter Window
- 3 Program Indicator
- 4 Power On Button
- 5 Input Selectors
- 6 AVR Selector
- 7 AM/FM Tuner Select
- 8 6-Channel Direct Input
- 9 Test Button
- 10 Sleep Button
- 11 Surround Mode Selector
- 12 Night Mode
- 13 Channel Select Button
- 14 ▲/▼ Buttons
- 15 ◀ Button
- 16 Set Button
- 17 Digital Select
- 18 Numeric Keys
- 19 Tuner Mode
- 20 Direct Button
- 21 Tuning Up/Down
- 22 On-Screen Display Button (OSD)
- 23 Dolby Mode Select Button
- 24 DTS Digital Mode Selector
- 25 Logic 7 Mode Select Button
- 26 Transport Controls
- 27 Tone Mode
- 28 Skip Up/Down Buttons
- 29 Stereo Mode Select Button
- 30 DTS Neo:6 Mode Select
- 31 Macro Buttons
- 32 RDS Selector Button
- 33 Preset Up/Down
- 34 Clear Button
- 35 Memory Button
- 36 Delay/Prev. Ch.
- 37 ▶ Button
- 38 Speaker Select
- 39 Mute
- 40 Volume Up/Down
- 41 The Bridge™ DMP Selector
- 42 TV/Video Selector
- 43 Dim Button

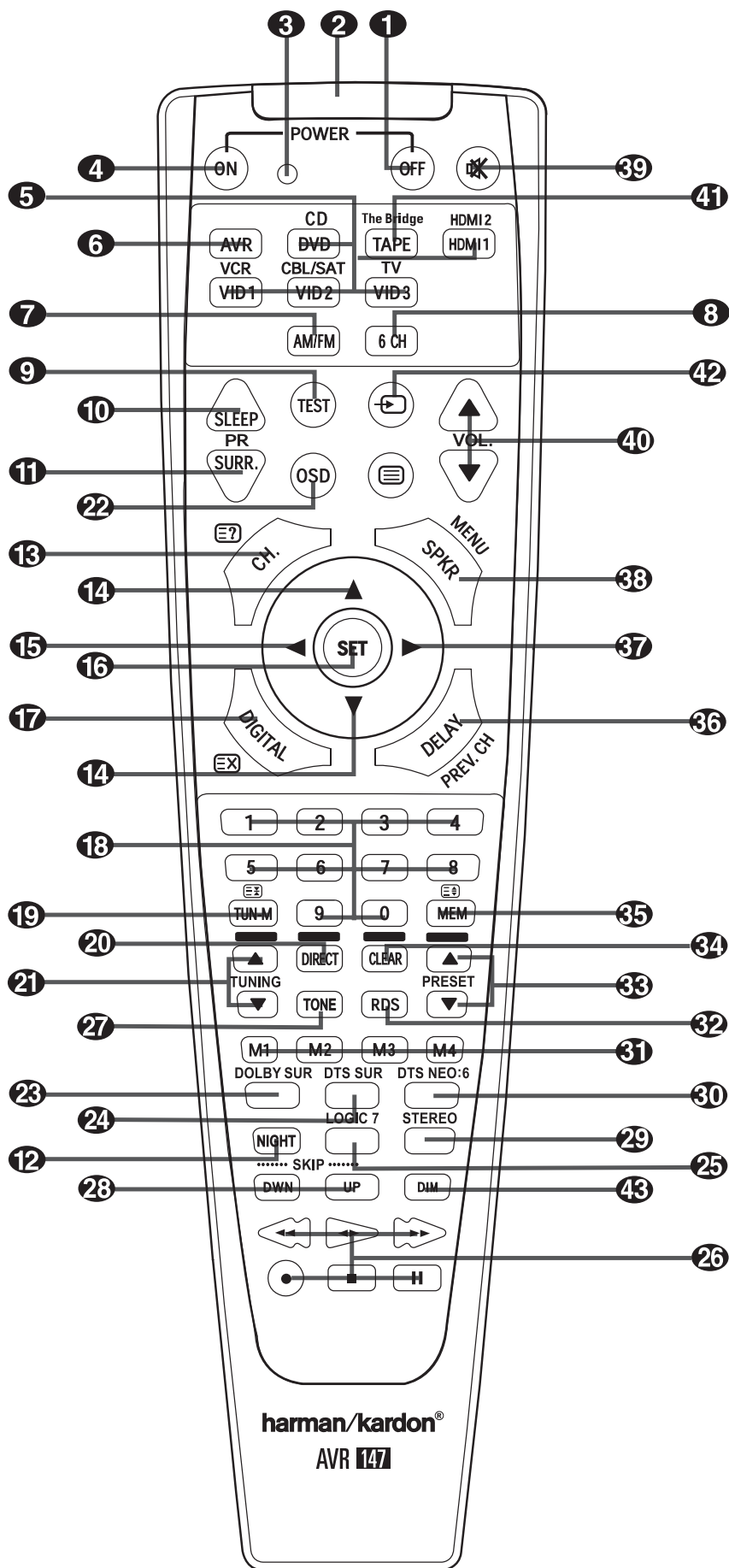

**NOTE:** The function names shown here are each button's feature when used with the AVR. Most buttons have additional functions when used with other devices. See page 46-47 for a list of these functions.

## Main Remote Control Functions

**IMPORTANT NOTE:** The AVR 147's remote may be programmed to control up to seven devices, including the AVR. Before using the remote, it is important to remember to press the **Input Selector** button **5** that corresponds to the unit you wish to operate. In addition, the AVR's remote is shipped from the factory to operate the AVR and most Harman Kardon CD or DVD players and cassette decks. The remote is also capable of operating a wide variety of other products using the control codes that are part of the remote. Before using the remote with other products, follow the instructions on pages 50-51 to program the proper codes for the products in your system.

It is also important to remember that many of the buttons on the remote take on different functions, depending on the product selected using the **Input Selector Button 5**. The descriptions shown here primarily detail the functions of the remote when it is used to operate the AVR. (See page 46-47 for information about alternate functions for the remote's buttons.)

- 1 Power Off Button:** Press this button to place the AVR or a selected device unit in the Standby mode.
- 2 IR Transmitter Window:** Point this window towards the AVR when pressing buttons on the remote to make certain that infrared commands are properly received.
- 3 Program Indicator:** This three-color indicator is used to guide you through the process of programming the remote. (See page 43 for information on programming the remote.)
- 4 Power On Button:** Press this button to turn on the power to a device selected by pressing one of the **Input Selectors 5** (except Tape).

**5 Input Selectors:** Pressing one of these buttons will perform three actions at the same time. First, if the AVR is not turned on, this will power up the unit. Next, it will select the source shown on the button as the input to the AVR. Finally, it will change the remote control so that it controls the device selected.

The buttons labeled DVD, TAPE and HDMI 1 are each used to select either of two input sources:

- The first press of the DVD Button selects the component connected to the DVD inputs. A second press of this button selects the component connected to the CD inputs.
- The first press of the button labeled TAPE selects Tape as the input. A second press of this button selects the The Bridge as an input.
- The first press of the HDMI 1 button selects the device that is connected to the HDMI 1 jack. A second press selects the device connected to the HDMI 2 jack.

After pressing one of these buttons you must press the **AVR Selector** button **6** again to operate the AVR's functions with the remote.

- 6 AVR Selector:** Pressing this button will switch the remote so that it will operate the AVR's functions. If the AVR is in the Standby mode, it will also turn the AVR on.
- 7 AM/FM Tuner Select:** Press this button to select the AVR's tuner as the listening choice. Pressing this button when the tuner is in use will select between the AM and FM bands.
- 8 6-Channel Direct Input:** Press this button to select the device connected to the **6-Channel Direct Inputs 10**.
- 9 Test Tone:** Press this button to begin the sequence used to calibrate the AVR's output levels. (See page 23-24 for more information on calibrating the AVR).

**10 Sleep Button:** Press this button to place the unit in the Sleep mode. After the time shown in the display, the AVR will automatically go into the Standby mode. Each press of the button changes the time until turn-off in the following order:

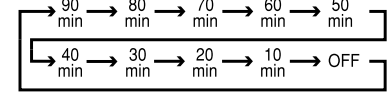

Hold the button pressed for two seconds to turn off the Sleep mode setting.

Note that this button is also used to change channels on your TV, VCR and Sat receiver when the appropriate source is selected, using the device **Input Selectors 5**.

**11 Surround Mode Selector:** Press this button to select any of the HALL, THEATER surround modes. Note that depending on the type of input, some modes are not always available. (See page 34-35 for more information about surround modes.) Note that this button is also used to tune channels on your TV, VCR and Sat receiver when the appropriate source is selected using the device **Input Selector 5**.

**12 Night Mode:** Press this button to activate the Night mode. This mode is available only with Dolby Digital encoded sources, and it preserves dialog (center channel) intelligibility at low volume levels (See page 36 for more information).

**13 Channel Select Button:** This button is used to start the process of setting the AVR's output levels with an external source. Once this button is pressed, use the **▲/▼** buttons **14** to select the channel being adjusted, then press the **Set** button **16**, followed by the **▲/▼** buttons **14** again, to change the level setting. (See page 23-24 for more information.)

**14 ▲/▼ Buttons:** These multipurpose buttons are used to change or scroll through items in the on-screen menus or on the front panel or to make configuration settings such as digital inputs or delay timing. When changing a setting, first press the button for the function or setting to be changed (e.g., press the **Digital Select Button 17** to change a digital input) and then press one of these buttons to scroll through the list of options or to increase or decrease a setting. The sections in this manual describing the individual features and functions contain specific information on using these buttons for each application.

When the AVR remote is being programmed for the codes of another device, these buttons are also used in the "Auto Search" process (See page 43 for more information on programming the remote.)

## Main Remote Control Functions

**15** ◀ **Button:** This button is used to change the menu selection or setting during some of the setup procedures for the AVR.

**16** **Set Button:** This button is used to enter settings into the AVR's memory. It is also used in the setup procedures for delay time, speaker configuration and channel output level adjustment.

**17** **Digital Select:** Press this button to assign one of the digital inputs **24****23****18****20** to a source. (See page 34 for more information on using digital inputs.)

**18** **Numeric Keys:** These buttons serve as a ten-button numeric keypad to enter tuner preset positions. They are also used to select channel numbers when **TV**, **VCR** or **Sat** receiver has been selected on the remote, or to select track numbers on a CD, DVD or LD player, depending on how the remote has been programmed.

**19** **Tuner Mode:** Press this button when the tuner is in use to select between automatic tuning and manual tuning. When the button is pressed so **MANUAL** appears in the **Main Information Display 23**, pressing the **Tuning** buttons **21****10** will move the frequency up or down in single-step increments. When the FM band is in use and **AUTO** appears in the **Main Information Display 23**, pressing this button will change to monaural reception making even weak stations audible. (See page 41 for more information.)

**20** **Direct Button:** Press this button when the tuner is in use to start the sequence for direct entry of a station's frequency. After pressing the button simply press the proper **Numeric Keys 18** to select a station (See page 41 for more information on the tuner).

**21** **Tuning Up/Down:** When the tuner is in use, these buttons will tune up or down through the selected frequency band. If the **Tuner Mode** button **19** has been pressed or the **Band** button **11** on the front panel was held pressed so that **AUTO** appears in the **Main Information Display 23**, pressing either of the buttons will cause the tuner to seek the next station with acceptable signal strength for quality reception. When the **MANUAL** appears in the **Main Information Display 23**, pressing these buttons will tune stations in single-step increments. (See page 41 for more information.)

**22** **OSD Button:** Press this button to activate the On Screen Display (OSD) system used to set up or adjust the AVR's parameters.

**23** **Dolby Mode Selector:** This button is used to select one of the available Dolby Surround processing modes. Each press of this button will select one of the Dolby Pro Logic II modes, Dolby 3 Stereo or Dolby Digital. Note that the Dolby Digital mode is only available with a digital input selected and the other modes only as long as a Dolby Digital source is not playing (except Pro Logic II with Dolby Digital 2.0 recordings, see page 35-36). See page 35 for the available Dolby surround mode options.

**24** **DTS Digital Mode Selector:** When a DTS source is in use the AVR will select the appropriate mode automatically and no other mode will be available. Pressing this button will display the mode currently selected by the AVR's decoder, depending on the surround material played and the speaker setting. When a DTS source is not in use, this button has no function. (See page 36 for the available DTS options.)

**25** **Logic 7 Selector:** Press this button to select one of the available Logic 7 surround modes. (See page 36 for the available Logic 7 options.)

**26** **Transport Control Buttons:** These buttons do not have any functions for the AVR, but they may be programmed for the forward/reverse play operation of a wide variety of CD or DVD players, and audio or video-cassette recorders. (See page 43 for more information on programming the remote.)

**27** **Tone Mode :** Pressing this button enables or disables the Balance, Bass and Treble tone controls. When the button is pressed so that the words **TONE IN** appear in the **Main Information Display 23**, the settings of the Bass and Treble controls and of the Balance control will affect the output signals. When the button is pressed so that the words **TONE OUT** appear in the **Main Information Display 23**, the output signal will be "flat", without any balance, bass or treble alteration.

**28** **Skip Up/Down Buttons:** These buttons do not have a direct function with the AVR, but when used with a compatibly programmed CD or DVD player/changer they will change the tracks on the disc currently being played.

**29** **Stereo Mode Selector:** Press this button to select a stereo playback mode. When the button is pressed so that **SURROUND OFF** appears in the **Main Information Display 23**, with only the **Surr Off Surround Mode Indicator 19** lit, the AVR will operate in a bypass mode with true fully analog, two-channel left/right stereo mode with no surround processing or bass management as opposed to other modes where digital processing is used. When the button is pressed so that **SURROUND OFF** appears in the **Main Information Display 23**, with both the **DSP** and **Surr Off Surround Mode Indicators 19** lit, you may enjoy a two-channel presentation of the sound along with the benefits of bass management. When the button is pressed so that **5 CH STEREO** appears, the stereo signal is routed to all five speakers, if installed. (See page 20-21 for more information on stereo playback modes).

**30** **DTS Neo:6 Mode Selector:** Pressing this selector button cycles the AVR through the various DTS Neo:6 modes, which extract a five-channel surround field from two-channel program material (from PCM source or analog input signal). The first press selects the last DTS Neo:6 surround mode that was in use, and each subsequent press selects the next mode.

**31** **Macro Buttons:** Press these buttons to store or recall a "Macro", which is a pre-programmed sequence of commands stored in the remote. (See page 44 for more information on storing and recalling macros).

**32** **RDS Select Button:** Press this button to display the various messages that are part of the RDS data system of the AVR's tuner. (See page 42 for more information on RDS).

**33** **Preset Up/Down:** When the tuner is in use, press these buttons to scroll through the stations programmed into the AVR's memory. When CD or DVD is selected using the **Input Selector** button **5**, these buttons may function as Slow Fwd/Rev (DVD) or "+10" (CD, CDR).

**34** **Clear Button:** Press this button to clear incorrect entries when using the remote to directly enter a radio station's frequency.

## Main Remote Control Functions

**35 Memory Button:** Press this button to enter a radio station into the AVR's preset memory. Two underline indicators will flash at the right side of the **Main Information Display 23**, you then have five seconds to enter a preset memory location using the **Numeric Keys 18**. (See page 41 for more information).



**36 Delay/Prev Ch.:** Press this button to begin the process for setting the delay times used by the AVR when processing surround sound. After pressing this button, the delay times are entered by pressing the **Set button 16** and then using the **▲/▼ buttons 14** to change the setting. Press the Set button again to complete the process. (See page 26 for more information).

**37 ► Button:** Press this button to change a setting or selection when configuring many of the AVR's settings.

**38 Speaker Select:** Press this button to begin the process of configuring the AVR's Bass Management System for use with the type of speakers used in your system. Once the button has been pressed, use the **▲/▼ buttons 14** to select the channel you wish to set up. Press the **Set Button 16** and then select the speaker type (Large, Small or None) appropriate with the speaker in use. (See page 24 for more information).

**39 Mute:** Press this button to momentarily silence the AVR or TV set being controlled, depending on which device has been selected. When the AVR remote is being programmed to operate another device, this button is pressed with the **Input Selector button 5** to begin the programming process. (See page 43 for more information on programming the remote).

**40 Volume Up/Down:** Press these buttons to raise or lower the system volume.

**41  Digital Media Player (DMP) Selector:** When Harman Kardon's  (optional) is connected to  **Digital Media Player (DMP) Connector 9** and a compatible Apple® iPod® is docked in , pressing this selector will select the iPod as the audio source input device for the AVR 147. In addition, if a video display is connected to one of the **Video Monitor Outputs 12**, the iPod's messages will appear on screen, and in the **Upper and Lower Display Lines 23**. The **▲/▼/◀/▶ Buttons 14 15 37**, the **Set Button 16** and the **Transport Controls 26** may be used to navigate the iPod and to operate many functions. See page 37, and the manuals for The Bridge and your iPod for more information.

**42 TV/Video Button:** This button does not have a direct function on the AVR, but when used with a compatibly programmed VCR, DVD or satellite receiver that has a "TV/Video" function, pressing this button will switch between the output of the player or receiver and the external video input to that player. Consult the Owner's Manual for your specific player or receiver for the details of how it implements this function.

**NOTE:** With the press of any remote button the **Input Selector button 5 6** associated with the button pressed will briefly flash red to confirm the transmission of the command, as long as there is a function for that button with the device selected (see function list on pages 46-47).

**43 Dim Button:** Press this button to activate the Dimmer function, which reduces the brightness of the front-panel display, or turns it off entirely. The first press of the button shows the default state. Press the button again to change the display to reduce the brightness by 50%, and press it again within five seconds and the main display will go completely dark. Note that this setting is temporary; regardless of any changes, the display will always return to full brightness when the AVR is turned on. The blue illumination around the **Power Indicator 3** will always remain at full brightness regardless of the setting to remind you that the AVR is still turned on.



# Installation and Connections

After unpacking the unit, and placing it on a solid surface capable of supporting its weight, you will need to make the connections to your audio and video equipment.

## Audio Equipment Connections

We recommend that you use high-quality interconnect cables when making connections to source equipment and recorders to preserve the integrity of the signals.

When making connections to audio source equipment or speakers it is always a good practice to unplug the unit from the AC wall outlet. This prevents any possibility of accidentally sending audio or transient signals to the speakers that may damage them.

1. Connect the analog output of a CD player to the **CD inputs** 7.

**NOTE:** When the CD player has both fixed and variable audio outputs it is best to use the fixed output unless you find that the input to the receiver is so low that the sound is noisy, or so high that the signal is distorted.

2. Connect the analog Play/Out jacks of a cassette deck, MD, CD-R or other audio recorder to the **Tape Input** jacks 3. Connect the analog Record/In jacks on the recorder to the **Tape Output** jacks 4 on the AVR.

3. Connect the digital output of any digital sources such as a CD or DVD changer or player, advanced video game, a digital satellite receiver, HDTV tuner or digital cable set-top box or the output of a compatible computer sound card to the **Optical** and **Coaxial Digital Inputs** 23 24 18 20.

We recommend connecting the coaxial digital audio output of your DVD player to the **Coax 1 Digital Audio Input** 24, since that digital input is assigned to the DVD source by default.

The Video 2/Cable/Sat source defaults to the **Optical 1 Digital Audio Input** 23. If your cable television set-top box or satellite receiver is equipped with an optical digital audio output, we recommend that you connect it to this input to obtain the benefits of higher-quality digital audio (such as PCM, Dolby Digital 2.0 or Dolby Digital 5.1 signals when broadcast by your cable or satellite provider).

4. Connect the **Coaxial or Optical Digital Outputs** 11 on the rear panel of the AVR to the matching digital input connections on a CD-R or MiniDisc recorder.

5. Assemble the AM Loop Antenna supplied with the unit as shown below. Connect it to the **AM** and **GND** screw terminals 1.

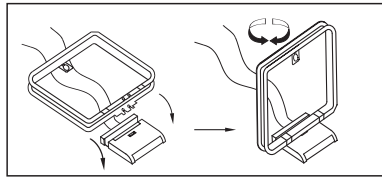

6. Connect the supplied FM antenna to the **FM (75 ohm)** connection 2. The FM antenna may be an external roof antenna, an inside powered or wire lead antenna or a connection from a cable system. Note that if the antenna or connection uses 300-ohm twin-lead cable, you should use a 300-ohm-to-75-ohm adapter to make the connection.

7. With the AVR 147 turned off, connect the optional Harman Kardon **Bridge** to **Bridge** **Digital Media Player (DMP) Connector** 9. Your compatible Apple® iPod® may be docked in **Bridge** when you wish to use it as your audio source device. Video materials stored on the iPod are not able to be viewed using the AVR.

8. Connect the front, center and surround speaker outputs 14 15 16 to the respective speakers.

To assure that all the audio signals are carried to your speakers without loss of clarity or resolution, we suggest that you use high-quality speaker cable. Many brands of cable are available and the choice of cable may be influenced by the distance between your speakers and the receiver, the type of speakers you use, personal preferences and other factors. Your dealer or installer is a valuable resource to consult in selecting the proper cable.

Regardless of the brand of cable selected, we recommend that you use a cable constructed of fine, multistrand copper with an area greater than 2 mm<sup>2</sup>.

Cable with an area of 1.5 mm<sup>2</sup> may be used for short runs of less than 4 m. We do not recommend that you use cables with an area less than 1mm<sup>2</sup> due to the power loss and degradation in performance that will occur.

Cables that are run inside walls should have the appropriate markings to indicate listing with any appropriate testing agency standards. Questions about running cables inside walls should be referred to your installer or a licensed electrician who is familiar with the applicable local building codes in your area.

When connecting wires to the speakers, be certain to observe proper polarity. Note that the positive (+) terminal of each speaker connection now carries a specific color code as noted on page 8. However, most speakers will still use a red terminal for the positive (+) connection. Connect the "negative" or "black" wire to the same terminal on both the receiver and the speaker.

**NOTE:** While most speaker manufacturers adhere to an industry convention of using black terminals for negative and red ones for positive, some manufacturers may vary from this configuration. To assure proper phase and optimal performance, consult the identification plate on your speaker or the speaker's manual to verify polarity. If you do not know the polarity of your speaker, ask your dealer for advice before proceeding, or consult the speaker's manufacturer.

We also recommend that the length of cable used to connect speaker pairs be identical. For example, use the same length piece of cable to connect the front-left and front-right or surround-left and surround-right speakers, even if the speakers are a different distance from the AVR.

9. Connections to a subwoofer are normally made via a line level audio connection from the **Subwoofer Output** 5 to the line-level input of a subwoofer with a built-in amplifier. When a passive subwoofer is used, the connection first goes to a power amplifier, which will be connected to one or more subwoofer speakers. If you are using a powered subwoofer that does not have line-level input connections, follow the instructions furnished with the speaker for connection information.

10. If an external multi-channel audio source with 5.1 outputs such as an external digital processor/decoder, DVD-Audio or SACD player is used, connect the outputs of that device to the **6-Channel Direct Inputs** 10.

## Video Equipment Connections

Video equipment is connected in the same manner as audio components. Again, the use of high-quality interconnect cables is recommended to preserve signal quality. To ensure best video performance S-Video sources should be connected to the AVR only with their S-Video In/Outputs, not with their composite video connectors too.

1. Connect a VCR's audio and video Play/Out jacks to the **Video 2 In** jacks 23 25 on the rear panel. The Audio and Video Record/In jacks on the VCR should be connected to the **Video 1 Out jacks** 26 8 on the AVR.

2. Although any video device may be connected to these jacks, we recommend connecting your TV to the **Audio 1 Audio/Video Input Jacks** 13 27 so that you may take advantage of the fact that the remote control is preprogrammed with TV product codes for the Video 1 device. For the same reason, we recommend connecting your video recorder, cable TV converter or satellite receiver to the **Video 2 Audio/Video Input Jacks** 23 25.

3. Connect the analog audio and video outputs of a DVD or laser disc player to the **DVD jacks** 6 13.



## Installation and Connections

4. Connect the digital audio outputs of a CD, MD or DVD player, satellite receiver, cable box or HDTV converter to the appropriate **Optical** or **Coaxial Digital Inputs** 23, 24, 18, 20.

Remember that the DVD source defaults to the **Coaxial 1 Digital Input** 23. All other sources default to their analog inputs, although any source may be assigned to any digital audio input on the receiver.

**NOTE:** When connecting a device such as a digital cable box or other set-top tuner product with a digital audio output, we recommend that you connect both the digital and analog outputs of the product to your AVR. The audio input polling feature of the AVR will then be able to make certain that you have a constant audio feed, since it will automatically switch the audio input to the analog jacks if the digital feed is interrupted or not available for a particular channel.

5. Connect the **Composite** and **S-Video** (if S-Video device is in use) **Monitor Output** 12 jacks on the receiver to the composite and S-Video input of your television monitor or video projector.

6. If your DVD player and monitor both have component video connections, connect the component outputs of the DVD player to the **Video 1 Component Video Inputs** 22. Note that even when component video connections are used the audio connections must still be made to either the analog **DVD Audio Inputs** 6 or any of the **Coaxial** or **Optical Digital Input** jacks 24, 23.

7. If another component video device is available, connect it to the **Video 2 Component Video Input** jacks 20. The audio connections for this device should be made to either the **Video 2 Input** jacks 25 or any of the **Coaxial** or **Optical Digital Input** jacks 24, 23.

8. If the component video inputs are used, connect the **Component Video Output** 21 to the component video inputs of your TV, projector or display device.

9. If you have a camcorder, video game or other audio/video device that is connected to the AVR on a temporary, rather than permanent basis, connect the audio, video and digital audio outputs of that device to the **Front Panel Inputs** 18, 20, 21. A device connected to the **Video 3 jacks** 21 is selected as the Video 3 input, and connected to the digital jacks 18, 20 it is selected as "Optical 3" or "Coaxial 3" input. (See page 18 for more information on input configuration.)

10. Connect the AVR to your video display using one of the following connections, even if you will also use an HDMI connection:

- If your video display has component video inputs (Y/Pr/Pb), connect the **Component Video Outputs** 21.
- If your display does not have digital or component video inputs, connect the **Video Monitor Output** 12 on the AVR to the matching input on your display. Only one connection is needed, and S-video is the higher quality signal.

### HDMI Connections

HDMI™ is the abbreviation for High-Definition Multimedia Interface, which is quickly becoming the standard connection point between advanced video/audio source products and displays, particularly for high-definition video signals. HDMI is a digital connection, eliminating the need to convert signals back and forth from digital to analog.

Some source or display components in your system may use DVI (Digital Video Interface) for digital video connections. DVI carries the same digital video signals as HDMI but uses a larger connector and does not transport audio or control signals. In most cases, you may mix and match DVI and HDMI digital video connections by using optional connector adapters. Note, however, that some DVI-equipped video displays are not compatible with the HDCP copy protection coding that is increasingly carried with signals connected via HDMI. If you have an HDMI source and a DVI-equipped display, you may occasionally be unable to view a program if the display does not include HDCP. This is not the fault of the AVR or your source; it simply indicates that the video display is not compatible.

The AVR 147 is equipped for HDMI switching, which means that it is able to select either of the two HDMI inputs as the source that feeds your system's video display. This preserves the digital signal in its original form by passing it directly through from source to display. However, this also means that the AVR does not have access to the signal and thus it is not able to add menus or on-screen messages to HDMI signals, or to process the audio that may be part of the signal in an HDMI connection.

Therefore, the following connections are required when the AVR 147 is used with HDMI sources:

- Connect the HDMI output of a source to either of the **HDMI Inputs** 32.
- Connect the **HDMI Output** 33 of the AVR to an HDMI input on your display.
- Connect either an optical or coaxial digital audio output from the source to the AVR. The default connections are **Coaxial 2** 24 for a source connected to **HDMI 1** 32 and **Optical 2** 23 for a source connected to **HDMI 2** 32. You may use any digital or analog

audio source in conjunction with the HDMI inputs, but if it varies from the default you must make a change to the input's setting, as shown on page 18.

- *Even when HDMI inputs are used, it is important to make sure that a component, S-video or composite video connection is made between the AVR and your display. This is needed to view both the setup menus and on-screen messages, and to view other (non-HDMI) video sources. The AVR 147 does not convert analog video signals to HDMI.*
- All component inputs/outputs can be used for RGB signals too, in the same way as described for the Y/Pr/Pb signals, then connected to the jacks with the corresponding color. But this is only correct as long as only the three RGB video signals are output by the video source, with a sync signal in the "G" signal only, without any sync signal output separately by the source.

### SCART A/V Connections

For the connections described above your video device needs RCA (cinch) connectors or/and S-Video connectors for all Audio and Video signals: Any normal video device (Not SVHS or High 8) for only playback needs 3 RCA jacks, VCRs for record and playback even 6 RCA jacks. Any S-Video device (SVHS, High 8) needs 2 RCA (Audio) and 1 S-Video jack (Video), if it's a playback unit, or 4 RCA (Audio In/Out) and 2 S-Video (Video In/Out) jacks, if it's a recording VCR.

Many European video devices are equipped with RCA (Cinch) or S-Video jacks only partially, not for all audio and video in/outputs needed as described above, but with a so called Scart or Euro-AV connector (almost rectangular jack with 21 pins, see drawings on next page).

In that case the following Scart to Cinch adapters or cables are needed:

- Units for playback, such as satellite receivers, camcorders, DVD or LD players, need an adapter from Scart to 3 RCA plugs, see fig. 1 (normal video devices) or from Scart to 2 RCA+1 S-Video plugs, see fig. 4 (S-Video devices).
- HiFi VCRs need an adapter from Scart to 6 RCA plugs, see fig. 2 (normal video), or from Scart to 4 Audio+2S-Video jacks, see fig. 5 (S-Video VCR). Read carefully the instruction attached to the adapter to find which of the six plugs is used for the record signal to the VCR (connect with the AVR's Out jacks) and for the playback signal from the VCR (connect with the AVR's In jacks). Do not misconnect Audio and Video signals. Don't hesitate to consult your dealer, if you are uncertain.

# Installation and Connections

- If you use only normal video devices the TV monitor needs an adapter from 3 RCA plugs to Scart (fig. 3) only. If also S-Video devices are used an adapter from 2 RCA + 1 S-Video plugs to Scart is needed additionally (fig. 6), connected to the SCART input on your TV that is provided for S-Video.

Note that only the video plugs (the "yellow" cinch plug in fig. 3 and the S-Video plug in fig. 6) must be connected to the **TV Monitor Output** 12, and the volume on the TV must be reduced to minimum.

### Important Note for Adapter Cables:

If the cinch connectors of the adapter you'll use are labeled, connect the Audio and Video "In" plugs with the corresponding Audio and Video "In" jacks on the AVR (and with a VCR connect the "Out" plugs to the "Out" jacks on the VCR). Note that with some adapter types it may be just turned around: If no signal is audible/visible when the VCR is playing connect the "Out" plugs to the "In" jacks on the AVR and turned around. If the adapter plugs are not labeled in that way, pay attention to the signal flow directions as shown in the diagrams above and in the instruction attached to the adapter. If uncertain, don't hesitate to consult your dealer.

### Important Notes for S-Video connections:

Only the S-Video In/Out of S-Video devices must be connected to the AVR, NOT both, normal video and S-Video In/Outputs (except the TV, see item below).

When both connections are made, only the S-Video signal will be viewed on the screen.

### Important Note for the Use of SCART-Cinch Adapters:

When video sources are connected to the TV directly with a SCART cable, specific control signals apart from Audio/Video signals will be fed to the TV. These specific signals are: With all video sources, the signal for automatic input selection that switches the TV automatically to the appropriate input as soon as the video source is started. And with DVD players, the signals automatically turning the TV to 4:3/16:9 format (with 16:9 TVs or with 4:3 TVs with selectable 16:9 format) and turning the RGB video decoder of the TV on or off, depending on the DVD player's setting. With any adapter cable, these control signals will be lost and the appropriate setting of the TV must be made manually.

### Note for RGB signal with SCART:

If you use a unit providing RGB signals on a SCART output (as e.g. most DVD players do) and you want to use that RGB signal, this SCART output must be connected directly to your TV. Although the AVR can switch three-way video signals (like component signals Y/Pb/Pr), most TVs need separate sync signals for RGB (also with SCART) that cannot be switched and provided by the AVR. RGB signals can be pathed through the

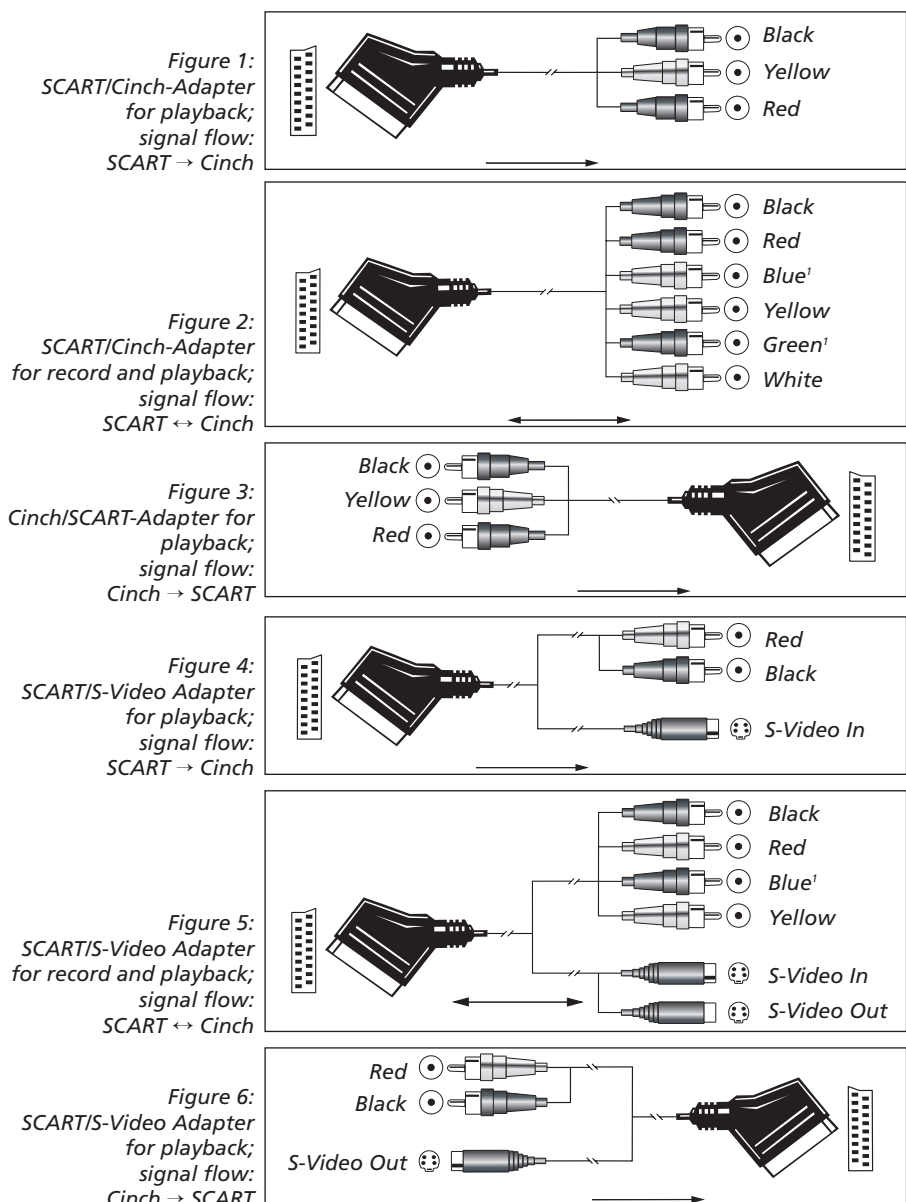

<sup>1</sup> Also other colours possible, e.g. brown and grey.

AVR only when no separate sync signal is needed (see last "Video Connection Note" on page 14).

## Power Connections

### AC Power Connections

This unit is equipped with one accessory AC outlets. It may be used to power Accessory devices, but it should not be used with high-current draw equipment such as power amplifiers. The total power draw to the **Switched** 17 Outlet must not exceed 50 watts.

The **Switched** 17 outlet will receive power only when the unit is on completely. This is recommended for devices that have no power switch or a mechanical power switch that may be left in the "ON" position.

**NOTE:** Many audio and video products go into a Standby mode when they are used with switched outlets, and cannot be fully turned on using the outlet alone without a remote control command.

The AVR draws significantly more current than other household devices such as computers that use removable power cords. For that reason, it is important that only the cord supplied with the unit (or a direct replacement of identical capacity) be used.

Once the power cord is connected, you are almost ready to enjoy the AVR 147's incredible power and fidelity!

# Installation and Connections

## Speaker Selection

No matter which type or brand of speakers is used, the same model or brand of speaker should be used for the front-left, center and front-right speakers. This creates a seamless front soundstage and eliminates the possibility of distracting sonic disturbances that occur when a sound moves across mismatched front-channel speakers.

## Speaker Placement

The placement of speakers in a multichannel home-theater system can have a noticeable impact on the quality of sound reproduced.

Depending on the type of center-channel speaker in use and your viewing device, place the center speaker either directly above or below your TV, or in the center behind a perforated front-projection screen.

Once the center-channel speaker is installed, position the left-front and right-front speakers so that they are as far away from one another as the center-channel speaker is from the preferred listening position. Ideally, the front-channel speakers should be placed so that their tweeters are no more than 60cm above or below the tweeter in the center-channel speaker.

They should also be at least 0.5 meter from your TV set unless the speakers are magnetically shielded to avoid colourings on the TV screen. Note that most speakers are not shielded, even with complete surround sets only the Center speaker may be.

Depending on the specifics of your room acoustics and the type of speakers in use, you may find that imaging is improved by moving the front-left and front-right speakers slightly forward of the center-channel speaker. If possible, adjust all front loudspeakers so that they are aimed at ear height when you are seated in the listening position.

Using these guidelines, you'll find that it takes some experimentation to find the correct location for the front speakers in your particular installation. Don't be afraid to move things around until the system sounds correct. Optimize your speakers so that audio transitions across the front of the room sound smooth.

When the AVR is used in 5.1-channel operation, the preferred location for surround speakers is on the side walls of the room, at or slightly behind the listening position.

Subwoofers produce largely nondirectional sound, so they may be placed almost anywhere in a room. Actual placement should be based on room size and shape and the type of subwoofer used. One method of finding the optimal location for a subwoofer is to begin by placing it in the front of the room, about 15 cm from a wall, or near the front corner of the room. Another method is to temporarily place the subwoofer in the spot where you will normally sit, and then walk around the room until you find a spot where the subwoofer sounds best. Place the subwoofer in that spot. You should also follow the instructions of the subwoofer's manufacturer, or you may wish to experiment with the best location for a subwoofer in your listening room.

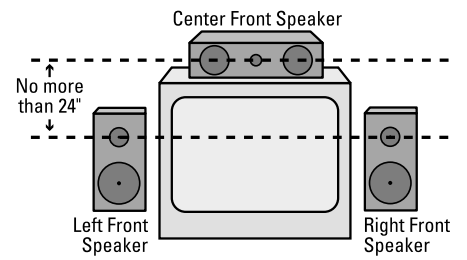

A) Front Channel Speaker Installation with Direct-View TV Sets or Rear-Screen Projectors

### 5.1-Channel System

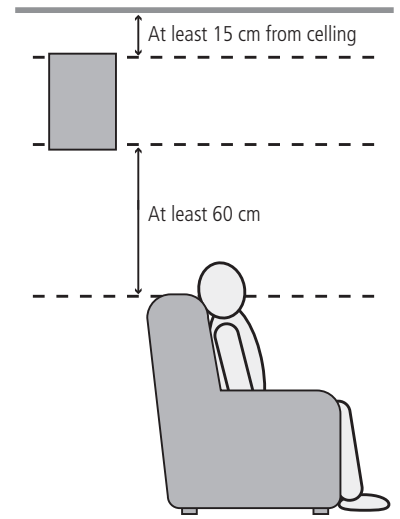
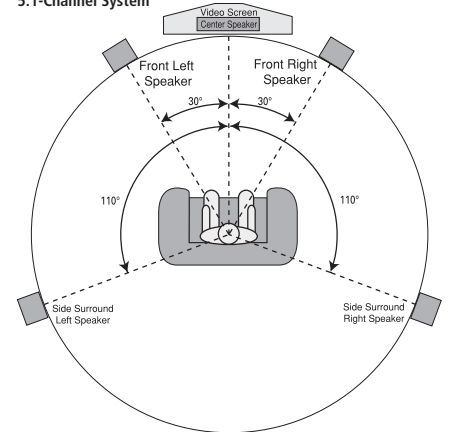

## System Configuration

Once the speakers have been placed in the room and connected, the remaining steps are to program the system configuration memories.

Although it is necessary to assign input/output settings and surround mode choices manually, we recommend that you take advantage of the power and precision of EzSet/EQ to automatically select and enter the settings for all other audio parameters. This will not only save you time; it will ensure that your room is calibrated and equalized with an accuracy not possible when these settings are made manually. You are now ready to power up the AVR 147 to begin these final adjustments.

### First Turn On

You are now ready to power up the AVR to begin these final adjustments.

1. Plug the **Power Cable 19** into an unswitched AC outlet.
2. Press the **Main Power Switch 1** in until it latches and the word "OFF" on the top of the switch disappears inside the front panel. Note that the **Power Indicator 3** will turn orange, indicating that the unit is in the Standby mode.
3. Remove the protective plastic film from the main front-panel lens. If left in place, the film may affect the performance of your remote control.
4. Install the three supplied AAA batteries in the remote as shown. Be certain to follow the (+) and (-) polarity indicators that are on the top of the battery compartment.

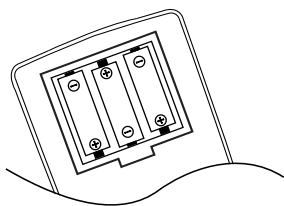

5. Turn the AVR on either by pressing the **System Power Control 2** or the **Input Source Selector 15** on the front panel, or via the remote by pressing the **Power On Button 4**, **AVR Selector 6** or any of the **Input Selectors 5 7** on the remote. The **Power Indicator 3** will turn blue to confirm that the unit is on, and the **Main Information Display 23** will also light up.

**NOTE:** After pressing one of the **Input Selector** buttons **5** to turn the unit on, press the **AVR Selector 6** to have the remote control the AVR functions.

### Using the On-Screen Display

When making the following adjustments, you may find them easier to make via the unit's on-screen display system. These easy-to-read displays give you a clear picture of the current status of the unit and facilitate speaker, delay, input or digital selection you are making.

To view the on-screen displays, make certain you have made a connection from the **Video Monitor Out** jack **12** on the rear panel to the composite or S-Video input of your TV or projector. In order to view the AVR's displays, the correct video input must be selected on your video display. Note that the on-screen menus are not available when a component video display is in use.

**NOTE:** The AVR 147 will not convert other types of video to HDMI, and you will not be able to view the on-screen displays using the HDMI connection.

**IMPORTANT NOTE:** When viewing the on-screen menus using a CRT-based projector, plasma display or any direct-view CRT monitor or television, it is important that they not be left on the screen for an extended period of time. As with any video display, but particularly with projectors, constant display of a static image such as these menus or video game images may cause the image to be permanently "burned into" the CRT. This type of damage is not covered by the AVR warranty and may not be covered by the projector TV set's warranty.

The AVR has two on-screen display modes, "Semi-OSD" and "Full-OSD." When making configuration adjustments, it is recommended that the Full-OSD mode be used. This will place a complete status report or option listing on the screen, making it easier to view the available options and make the settings on the screen. The Semi-OSD mode uses one-line displays only.

Note that when the full OSD system is in use, the menu selections are not shown in the **Information Display 23**. When the full OSD menu system is used, **OSD ON** will appear in the **Main Information Display 23** to remind you that a video display must be used.

When the semi-OSD system is used in conjunction with the discrete configuration buttons, the on screen display will show a single line of text with the current menu selection. That selection will also be shown in the **Main Information Display 23**.

The full OSD system can always be turned on or off by pressing the **OSD** button **22**. When this button is pressed the **MASTER MENU** (Figure 1) will appear, and adjustments are made from the individual menus. Note that the menus will remain on the screen for 20 seconds after the latest action was made on the screen menu, then they will "time-out" and disappear from the screen. The time-out may be increased to as

much as 50 seconds by going to the **SYSTEM SETUP** menu, and changing the item titled **FULL OSD TIME OUT**.

The semi-OSD system is also available as a system default, although it may be turned off by using the **SYSTEM SETUP** menu. (See page 39). With the semi-OSD system, you may make adjustments directly, by pressing the buttons on the front panel or remote control for the specific parameter to be adjusted. For example, to change the digital input for any of the sources, press the **Digital Select Button 25 17** and then any of the **Selector buttons** **7** or **14** on the front panel or remote.



Figure 1

### System Setup

The AVR 147 features an advanced memory system that enables you to establish different configurations for the speaker configuration, digital input, surround mode, delay times, crossover frequencies and speaker setting for each input source. To ease the speaker setting, the same speaker setting can also be made for all inputs. This flexibility enables you to custom tailor the way in which you listen to each source and have the AVR memorize them. This means, for example, that you may associate different surround modes and analog or digital inputs with different sources, or set different speaker configurations with the resultant changes to the bass management system or the use of the center speaker and/or the Subwoofer. Once these settings are made, they will automatically be recalled whenever you select that input.

However, we recommend that the first time you use the AVR, you take advantage of the simplicity of configuring the system using the EzSet/EQ process, which takes the guesswork out of speaker size and delay settings, and balances the speaker output levels to tailor the AVR's sound presentation to your specific system and room. Before beginning the EzSet/EQ procedure, there are a few adjustments that need to be made to ensure accurate results.

The factory default settings for the AVR 147 have all inputs configured for an analog audio input except for the DVD input, where the **Coaxial Digital Input 24** is the default and the Video 2 input, where the **Optical Digital Audio Input 28** is the default. Once the DSP processing system is used for the first time for any input, the



## System Configuration

speaker settings will automatically default to "Small" at all positions with the subwoofer set to "LFE." The default setting for the surround modes is Logic 7 Music, although Dolby Digital or DTS will automatically be selected as appropriate when a source with digital encoding is in use.

Before using the unit, you will probably want to change the settings for most inputs so that they are properly configured to reflect the use of digital or analog inputs and the surround mode associated with the input. Remember that since the AVR memorizes the settings for each input individually, you will need to make these adjustments for each input used. However, once they are made, further adjustment is only required when system components are changed.

To make this process as quick and as easy as possible, we suggest that you use the full-OSD system with the on-screen menus, and step through each input.

It is recommended that you record your settings for each input using the work-sheets in the appendix to this manual, in the event there is a power loss or if you need to reenter the settings for some other reason.

### Input Setup

The first step in configuring the AVR is to select an input, i.e. to associate an analog or digital input with each input source in use, e.g. **CD** or **DVD**. Note that once an input is selected, all settings for the Digital Input, Speaker Configuration, Delay and Surround Mode will "attach" themselves to that input and be stored in a nonvolatile memory. This means that once made, the selection of an input will automatically recall those settings. For that reason, the procedures described below must be repeated for each input source so that you have the opportunity to custom tailor each source to your specific listening requirements. However, once made they need not be changed again unless you need to alter a setting.

When using the full-OSD system to make the setup adjustments, press the **OSD** button **22** once so that the **MASTER MENU** (Figure 1) appears. Note that the **▶** cursor will be next to the **INPUT SETUP** line. Press the **Set** button **16** to enter the menu and the **INPUT SETUP** menu (Figure 2) will appear on the screen. Press the **◀▶** buttons **15 37** until the desired input name appears in the highlighted video, as well as being indicated in the front panel **Input Indicators 22** by the blue LED next to the desired input name. If the input will use the standard left/right analog inputs, no further adjustment is needed.

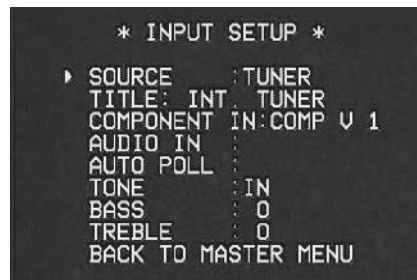

Figure 2

The AVR offers you the option of renaming each input (except tuner) as it appears in the on-screen and front panel messages. This is helpful if you have more than one VCR, if you wish to associate a specific product brand name with the input, or to simply enter any name that will help you to remember which source is being selected.

To change the input name, press the **▲▼** **Navigation Button 14** on the remote so that the **→** cursor is pointing to **TITLE**. Next, press and hold the **Set Button 16** for a few seconds until a flashing box appears to the right of the colon. Immediately release the **Set Button 16**, as you are now ready to enter the device name.

Press the **▲▼** **Navigation Button 14** and note that a complete set of alpha-numeric characters will appear with the start of the alphabet in capital letters followed by the lower-case letters and then numbers and symbols. When you press the **▼** **Navigation Button 14**, a series of symbols and numbers will appear, followed by a reverse list of the alphabet in lower-case letters. Press the button either way until the first letter of the desired name appears. If you wish to enter a blank space as the first character, press the **▶** **Navigation Button 37**.

When the desired character appears, press the **▶** **Navigation Button 37** and repeat the process for the next letter, and continue until the desired name is entered, up to a maximum of fourteen characters.

Press the **Set Button 16** to enter the input name into the system memory and to proceed with the configuration process.

If your system includes any sources that are equipped with Y/Pr/Pb component video outputs, the AVR is able to switch them to send the proper signals to your video display. All **Component Video Inputs 20 22** may be assigned to any source for added system flexibility. The default setting is for the **Video 1 Component Video Input 22** to be assigned to the DVD, with the **Component Video 2 Jacks 20** assigned to the other inputs. If your system does not include component video at this time, or if you do not need to change these defaults, press the **▼** **Navigation Button 14** to go to the next setting.

To change the Component Video assignment, first make certain that the **→** cursor is pointing to the **COMPONENT IN** line on the menu screen, and then press the **◀▶** **Navigation Button 15 37** until you see the desired input in the highlighted video. The clicking noise that you will hear when the component video inputs is switched is normal, due to the relay used to ensure proper isolation between the three inputs.

When the desired component input has been selected, press the **▼** **Navigation Button 14** go to the next setting.

**AUDIO IN:** By default, the analog audio inputs are assigned at the factory to all sources, with the following exceptions:

Source Input	Default Digital Audio Input
DVD	Coax 1
Video 2	Optical 1
HDMI 1	Coax 2
HDMI 2	Optical 2

Table – Default Digital Audio Assignments

If you used a digital audio connection for another source, you will need to change this setting to assign the correct digital audio input to the source, even if you also connected the analog audio outputs of the source to the receiver. Move the cursor to this line, and press the **◀▶** **Buttons** until the correct digital input appears.

Some digital video input sources, such as a cable box or HDTV set-top may change between analog and digital outputs, depending on which channel is in use. The AVR's Auto Polling feature allows you to avoid losing the audio feed when this happens by permitting both analog and digital connections to the same source on the AVR. Digital audio is the default, and the unit will automatically switch to the analog audio if the digital audio stream stops.

In cases where only a digital source is used, you may wish to disable the Auto Polling feature to prevent the AVR from trying to "find" an analog source when the digital source is paused. To turn Auto Polling off for any input, first make certain that the **→** cursor is pointing to the **AUTO POLL** line on the menu screen. Next, press the **◀▶** **Navigation Button 15 37** so that **OFF** is highlighted in reverse video. Repeat the procedure at any time by highlighting **ON** to restore the Auto Polling feature.

**DMP SETTING:** If you select DMP/The Bridge as your source input, you will notice that the **AUDIO IN** line of the **INPUT SETUP** menu has been replaced by the option **GO TO DMP SETTING**. See Figure 3.



# System Configuration

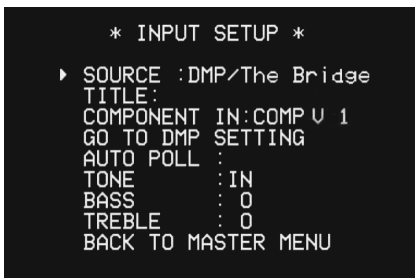

Figure 3

Since The Bridge is connected to the AVR using a dedicated audio connection, it isn't possible to select a different audio input for this source. However, there are several special settings used only with The Bridge. Selecting **GO TO DMP SETTING** displays the **DMP SETTING** menu (see Figure 4).



Figure 4

**MODE:** The first line of the **DMP SETTING** menu indicates that the iPod will be used to listen to music (or other audio materials) or view videos or still images, if you have a video or photo iPod.

**REPEAT:** Set **REPEAT** to **ONE**, **ALL** or **OFF** to repeat one track, all tracks in an album or playlist, or not to repeat any tracks.

**SHUFFLE:** Set **SHUFFLE** to **SONGS** to play all songs on the iPod in random order. The **ALBUMS** setting plays all albums in random order, with each album's tracks played in album order.

**RESUME:** Set **RESUME** to **ON** to resume playback of a track from the point where it was interrupted by turning off the AVR, switching sources on the AVR, or removing the iPod from The Bridge. Set **RESUME** to **OFF** if you wish to restart play from the beginning of the track after interruptions.

**CHARGE IN ST-BY:** Your iPod will automatically charge its battery while docked in The Bridge with the AVR turned on. Set **CHARGE IN ST-BY** to **ON** to enable charging even when the AVR is in Standby mode (but not completely off). When **CHARGE IN ST-BY** is set to **OFF**, the iPod will only charge when the AVR is turned on.

**Note:** In order to access the **DMP SETTING** menu, you need to press the AVR Selector on the remote so that it operates the AVR 147. You may then press the OSD Button and use the Navigation and Set Buttons, as usual, with the

on-screen menu system. When you are ready to return to operation of your iPod using the remote, remember to press the DMP/The Bridge Selector so that the transport and other controls operate The Bridge.

To simplify use, you may wish to program two macros on your remote, one to select the AVR and issue the commands within the OSD system to display the **DMP SETTING** menu, and a second macro to remove the menu from the display and return the remote to operation of The Bridge. See the Macros section of the Advanced Functions section of the manual for more information on programming macros.

The next lines in the Input Setup menu control whether or not the bass/treble tone controls are in the signal path. The normal default is for them to be in-line, but if you wish to remove them from the circuit for "flat" response, first make certain that the → cursor is pointing to the **TONE** line on the menu and press the ◀▶ **Navigation Button 15** so that **OUT** is highlighted in reverse video.

If you wish to leave the tone controls in the signal path, the amount of boost or cut for bass and treble may be adjusted by pressing the ▲▼ **Navigation Button 14** so that the → cursor is next to the line for the setting you wish to adjust. Next, press the ◀▶ **Navigation Button 15** until the desired setting is shown.

When all needed adjustments have been made, press the ▼ **Button 14** until the → cursor is next to **BACK TO MASTER MENU** to continue with the system configuration.

### Surround Setup

The next step for that input is to set the surround mode you wish to use with that input. Since surround modes are a matter of personal taste, feel free to select any mode you wish – you may change it later. The Surround Mode chart on page 30-32 may help you select the mode best suited to the input source selected. For example you may select Dolby Pro Logic II or Logic 7 for most analog inputs and Dolby Digital for inputs connected to digital sources. In the case of inputs such as a CD Player, Tape Deck or Tuner, you may wish to set the mode to Stereo, if that is your preferred listening mode for standard stereo sources, where it is unlikely that surround encoded material will be used. Alternatively, the 5 Channel Stereo or Logic 7 Music mode may also be a good choice for stereo-only source material.

It is easiest to complete the surround setup using the full-OSD on-screen menus. From the **MASTER** menu (Figure 1), press the ▲▼ **buttons 14** until the → cursor is next to the **SURROUND SELECT** menu. Press the **Set Button 16** so that the **SURROUND SELECT** menu (Figure 5) is on the screen.

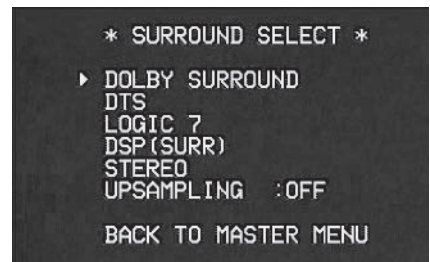

Figure 5

Each of the option lines on this menu (Figure 5) selects the surround mode category, and within each of those categories there will be a choice of the specific mode options.

**Note:** When a Dolby Digital or DTS source is selected and playing, the AVR will select the appropriate surround mode automatically, no matter which surround mode was selected for that input as default. Then no other surround modes will be available, except all Pro Logic II modes with Dolby Digital 2 channel (2.0) recordings (see page 33).

To select the mode that will be used as the initial default for an input, first press the ▲▼ **buttons 14** until the on-screen cursor is next to the desired mode's master category name. Next, press the **Set Button 16** to view the sub-menu. Press the ◀▶ **Buttons 15 37** to scroll through the available choices, and then press the ▼ **Button 14** so that the cursor is next to **BACK TO MASTER MENU** to continue the setup process.

On the **DOLBY SURROUND** menu (Figure 6), the selection choices include Dolby Digital, Dolby Pro Logic II Music, Dolby Pro Logic II Cinema, Dolby Pro Logic II and Dolby 3 Stereo. A complete explanation of these modes is found on Page 30-31. Note that when the Dolby Digital mode is selected there are additional settings available for the Night mode that are associated with the surround mode only, not with the input. That's why these settings must be made only once, not with each input in use. They are described later in the next main chapter (see below).

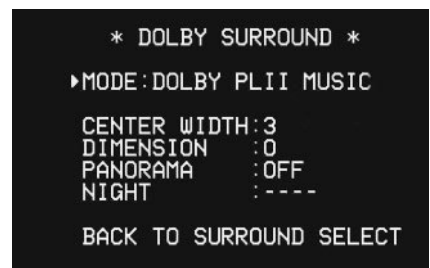

Figure 6

When the → cursor is pointing to the **MODE** line, press the ◀▶ **Navigation Buttons 15 37** to select the desired Dolby surround mode, again remembering that the choice of available modes will vary with the type of program material being played and the number of speakers in your system configuration.

## System Configuration

When Dolby Pro Logic II Music is selected as the listening mode, three special settings are available to tailor the sound field to your listening room environment and your individual taste and preferences. (When other Dolby Surround modes are selected, dotted lines will indicate that these settings are not active.)

- **Center Width:** This setting adjusts the balance of the vocal information in the front soundstage between the center and front left/right speakers. The lower settings spread the center channel sound more broadly into the left and right channels. A higher number (up to "7") produces a tighter center channel presentation.
- **Dimension:** This setting alters the perceived depth of the surround field by creating a shallower presentation that appears to move sounds toward the front of the room, or a deeper presentation that appears to move the center of the sound field toward the back of the room. The setting of "0" is a neutral default, with the range of adjustment shown as "R-3" for a deeper, rear-oriented sound to "F-3" for a shallower, front-oriented sound.
- **Panorama:** Switch this setting on or off to add an enveloping wrap-around presentation that increases the perception of sound along the sides of the room.

To change these parameters, press the **▲/▼ Navigation Buttons 14** while the **DOLBY SURROUND** menu is on the screen until the → cursor is pointing to the line on the menu with the parameter you wish to change. Then, press the **◀▶ Navigation Buttons 15 37** to alter the setting to your taste.

Note that when the Dolby Digital mode is selected there are additional settings available for the Night mode that are associated with the surround mode only, not with the input. That's why these settings must be made only once, not with each input in use.

### Night Mode Settings

The Night mode is a feature of Dolby Digital that uses special processing to preserve the dynamic range and full intelligibility of a movie sound track while reducing the peak level.

This prevents abruptly loud transitions from disturbing others, without reducing the sonic impact of a digital source. Note that the Night mode is only available when the Dolby Digital surround mode is selected.

To adjust the Night mode setting from the menu press the **OSD Button 22** so that the **MASTER** menu appears. Then press the **▼ button 14** to access the **SURROUND SETUP** menu. Press **Set 16** to select the **DOLBY** menu.

To adjust the Night mode setting, make certain that the → cursor is on the **NIIGHT** line of the **DOLBY** menu. Next, press **◀▶ Buttons**

**15 37** to choose between the following settings.

**OFF:** When **OFF** is highlighted, the Night mode will not function.

**MID:** When **MID** is in the highlighted video, a mild compression will be applied.

**MAX:** When **MAX** is in the highlighted video, a more severe compression algorithm will be applied.

When you want to use the Night mode feature, we recommend that you select the MID setting as a starting point and change to the MAX setting later, if desired.

Note that the Night mode may be adjusted directly any time that Dolby Digital surround mode is selected by pressing the **Night button 12**. When the button is pressed, the words **D-RANGE** followed by the current setting (**MID**, **MAX**, **OFF**) will appear in the lower third of the video screen and in the **Main Information Display 23**. Press the **▲/▼ buttons 14** within five seconds to select the desired setting, then press **Set 16** to confirm the setting.

On the **DTS** menu, the selection choices made with the **◀▶ Buttons 15 37** on the remote are determined by the type of DTS program material in use.

When the 5.1 configuration is in use the AVR will automatically select the 5.1 version of DTS processing when a DTS data stream is received.

When a DTS 96/24 signal is detected, the AVR 147 defaults to the DTS surround mode, but reproduces the higher-resolution materials that are present due to the higher sampling rate automatically. See page 30 and 31 for a complete explanation of the DTS modes.

On the **LOGIC 7** menu, the selection choices made with the **◀▶ Buttons 15 37** on the remote enable Harman Kardon's exclusive Logic 7 processing to create fully enveloping, multi-channel surround from either two-channel Stereo or Matrix-encoded programming such as VHS cassettes, laserdiscs or television broadcasts produced with Dolby surround.

You may select the Logic 7/5.1 Music, Cinema or Enhanced modes. They work best with two-channel music, surround-encoded programs or standard two-channel programming of any type, respectively. Note that the Logic 7 modes are not available when either Dolby Digital or DTS Digital soundtracks are in use.

On the **DSP (SURR)** menu, the selection choices made with the **◀▶ Buttons 15 37** on the remote select one of the DSP surround modes that are designed for use with two-channel stereo programs to create a variety of sound field presentations. The choices available are Hall 1,

Hall 2, Theater. The Hall and Theater modes are designed for multichannel installations. See pages 30-31 for a complete explanation of the DSP surround modes. Note that the Hall and Theater modes are not available when a Dolby Digital or DTS soundtrack is played.

On the **STEREO** menu, the selection choices made with the **◀▶ Buttons 15 37** on the remote may either turn the surround processing off for a traditional two-channel stereo presentation, or select **5 CH Stereo**. The latter modes feed the stereophonic input signal to both front speakers, to the rear speakers and to both surround back speakers (if in use), while the monophonic signal parts are spread over all speakers, also the Center. See page 30-31 for a complete explanation of the 5 CH Stereo modes.

After the selections are made in the Dolby, DTS, Logic 7, DSP (Surround) or Stereo menus, press the **▲/▼ buttons 14** so that the cursor moves to the **BACK TO SURR SELECT** line and press the **Set Button 16**.

### Configuring the Surround Off (Stereo) Modes

For superior reproduction of two-channel program materials, the AVR offers two Stereo modes: an analog Stereo-Direct mode that bypasses the digital signal processing circuitry for a completely analog signal path that preserves the purity of the original signal, and a digital mode that is capable of providing bass management for optimal distribution of the low frequencies between smaller speakers and a subwoofer.

#### Stereo-Direct (Bypass) Mode

When the analog Stereo-Direct mode is selected by pressing the **Stereo Mode Selector 29** until **SURROUND OFF** appears in the **Main Information Display 23** and the **Surround Mode Indicator 19** for Surround Off is lit, the AVR will pass the analog source material directly through to the front left and right speakers, bypassing the digital processing circuitry.

In this mode, the front left and right speakers will automatically be configured as **LARGE**; it is not possible to configure these speakers as **SMALL**.

When the AVR is in the Stereo Bypass mode you may still configure the subwoofer output so that it is either turned off, with a full-range signal going to the front left/right speakers, or you may configure it so that the subwoofer feed is activated.

The factory default setting is to have the subwoofer turned off for this mode, but you may change that setting by following these steps:

1. Press the **Speaker Button 6 38**.
2. Press the **Set Button 16 12** to activate the configuration menu.

## System Configuration

3. Press the ▲/▼ Buttons **14** on the remote or the ◀/▶ Buttons **7** on the front panel to select the desired option. **SUB NONE** turns off the feed to the subwoofer, while **SUB <L+R>** turns it on.
4. When the desired setting has been entered, press the **Set Button 16 12** to return to normal operation.

### Stereo-Digital Mode

When the Stereo-Direct (Bypass) mode is in use a full range signal is always sent to the front left/right speakers. By its nature, that option does not pass the signal through the AVR's digital signal processing, creating the requirement for full-range speakers. If your front speakers are bandwidth limited, "satellite" speakers, we recommend that you do NOT use the Bypass mode, but rather use the **DSP SURROUND OFF** mode for stereo listening.

To listen to programs in the two-channel stereo mode while taking advantage of the bass management system, press the **Stereo Mode Selector 29** until **SURROUND OFF** appears in the **Main Information Display 23** and the **DSP and SURR • OFF Surround Mode Indicators 19** both light up. When only the **SURR • OFF Surround Mode Indicators 19** is lit you are in the Stereo-Direct (Bypass) mode.

When this mode is in use, the front left/right speakers and subwoofer may be configured to meet the requirements of your specific speakers using the steps shown in the Speaker Setup section below.

The last option line in this menu is the setting to turn the unit's upsampling feature on or off. In normal use, this feature is turned off, which means that digital sources are processed at their native sample rate. For example, a 48kHz digital source will be processed at 48kHz. However, the AVR allows you to upsample the incoming 48kHz signals to 96kHz for added resolution.

To take advantage of this feature, press the ▲/▼ Navigation Button **14** so that the → cursor is next to the **UPSAMPLING** line and press the ◀/▶ Navigation Button **15 37** so that **ON** is highlighted in reverse video. Note that this feature is only available for the Dolby Pro Logic II-Music, Dolby Pro Logic II-Movie, Dolby Pro Logic and Dolby 3 Stereo modes.

### Automated Speaker Setup Using EzSet/EQ

The AVR 147 is one of the first receivers in its class to offer automated speaker setup and system calibration. This process greatly simplifies the installation of your new receiver by using a series of test signals and the power of an advanced digital signal processing system to eliminate the need for manual adjustment of speaker "size", crossover, delay and output level settings, while adding the power of a multi-band parametric equalizer to smooth out any peculiarities in frequency response that may result from the characteristics of the listening room. With EzSet/EQ your new receiver even alerts you to errors in speaker connections that prevent a speaker from functioning.

With EzSet/EQ you are able to calibrate your system in a fraction of the time it would take to enter the settings manually, and with results that rival those achieved with expensive test equipment and time-consuming procedures. The end result is a system calibration profile that enables your new receiver to deliver the best possible sound, no matter what type of speakers you have or what the dimensions of your listening room are.

We recommend that you take advantage of the precision of EzSet/EQ to calibrate your system, but if desired you may also make any of the configuration settings manually, or trim the settings provided by EzSet/EQ by following the instructions on pages 23 through 27.

If you wish to configure your AVR manually, or if for some reason your EzSet/EQ microphone is unavailable, you may still do so by following the instructions on pages 23 through 27.

**Step 1:** EzSet/EQ requires that your listening room have as little background noise as possible to avoid interfering with the measurement of tones produced by your AVR during the setup procedure. Turn off all loud fans, air conditioners and other equipment, and try to avoid making any noise during the process.

**Step 2:** The EzSet/EQ microphone should be placed in either your usual listening position or, if there is a large seating area, the center of the room, at the listeners' ear level. You may find it convenient to use a camera tripod for stable placement of the EzSet/EQ microphone at the correct height. The microphone includes a threaded insert on the bottom for tripod mounting.

**Step 3:** Plug the EzSet/EQ microphone into the AVR 147's **Headphone Jack 4**, making certain that the mini-plug to 1/4" phone plug adaptor supplied with the microphone is firmly connected. The microphone cable is approximately 7 meter long, which should accommodate most listening room situations. If required, you may use an

optional extension cable, available at most electronics stores, for use in larger rooms. However, we recommend that you avoid using extension cords for the microphone cable, as they may adversely affect the test results.

**Step 4:** Once the microphone is properly positioned and plugged in, proceed to the EzSet/EQ menus by first pressing the **OSD Button 22** to bring the Master Menu to the screen. Next, press the ▲/▼ Navigation Buttons **14** to move the on-screen cursor to the **EZSET/EQ** menu line. Press the **Set Button 16** to move to the next screen (Figure 7a).

**Step 5:** The first screen of the EzSet/EQ system will now appear to remind you to plug in the microphone. If you have not already done so, plug the microphone into the **Headphone Jack 4** as described in steps 2 and 3. When you are ready to proceed, make certain that the cursor is pointing to **YES** and press the **Set Button 16**. If you do not wish to continue with the EzSet+ process, press the ◀/▶ Navigation Buttons **15 37** and then press the **Set Button 16** to return to the **MASTER MENU**. Note that if you attempt to move to the next menu without plugging in the microphone, a reminder message will flash at the bottom of the screen.

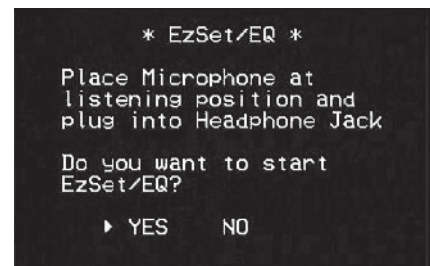

Figure 7a

**Step 6:** After entering **YES** to start the EzSet/EQ system, you will next see a brief warning message, and the screen will then change to the main EzSet/EQ menu. The **WARNING** screen is a reminder that in order for the system to perform accurate measurements, it is important that the listening room be as quiet as possible. After 5 seconds, the screen will change again to display the main EzSet/EQ menu (Figure 7b).

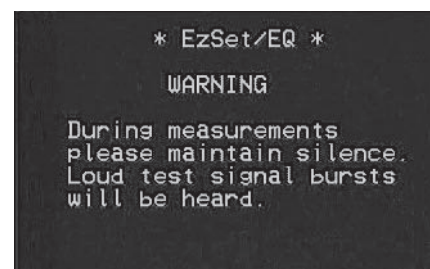

Figure 7b

**IMPORTANT NOTE:** Anyone with hearing that is sensitive to loud noises should leave the room at this point, or use ear protection sufficient to



## System Configuration

reduce the noise level. Inexpensive foam-style ear plugs, available at most drug stores, may be used to reduce the sound level to a tolerable level. If you are uncomfortable with, or cannot tolerate, loud sounds and do not use some sort of ear protection, we strongly recommend that you leave the room and ask someone else to run the EzSet/EQ process, or that you do not use EzSet/EQ and enter the configuration settings manually, as described on pages 23 through 27.

**Step 7:** The **WARNING** screen will automatically be replaced by the main EzSet/EQ menu (Figure 7c).



Figure 7c

While this screen is visible, you may start and stop the calibration process, or monitor the progress of the measurements and view the results. When the screen first appears, you will see **MEASUREMENT : STOP** on the first line of the menu list. To start the EzSet/EQ test process, you must first tell the system how many speakers are in your system. To do that, choose one of these two options:

- If your system includes a full complement of seven main speakers (front left/center/front right/surround right/surround back right/surround back left/surround left) and a subwoofer, press the **Navigation Buttons 15 37** so that 7.1 appears to the right of **MEASUREMENT**, and then press the **Set Button 16** to start EzSet/EQ.
- If your system includes a traditional surround speaker complement of five main speakers (front left/center/ front right/surround right/ surround left) and a subwoofer, press the **Navigation Buttons 15 37** so that 5.1 appears to the right of **MEASUREMENT**, and then press the **Set Button 16** to start EzSet/EQ. To stop the calibration process at any time, press the **Navigation Buttons 14** to move the on-screen cursors to the **MEASUREMENT** line; press the **Navigation Buttons 15 37** so that **STOP** appears and press the **Set Button 16**.

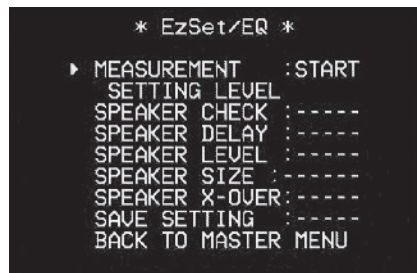

Figure 7d

**Step 8:** Once EzSet/EQ has been started, you will hear test signals circulate among all of the speakers as the system sets the master level, checks to see where there are speakers, sets the distance measurement and calculates delay time settings, sets the speaker "size", and sets the speaker crossover point. During the measurement and calibration process, you may observe the progress of the testing by reading the messages that appear in the second line of the menu listing. When the EzSet/EQ screen first appears, it contains a series of dashes, but as the test and measurement proceeds, you will see the following messages as the individual measurements are taken:

- **System Level:** A **SETTING VOLUME** message will appear to indicate that the system is setting the overall volume level to the proper level as a prelude to testing the individual channels. During this test, you will see a message in the last line of the menu screen change as the volume level is adjusted.

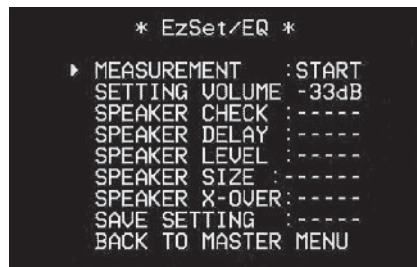

Figure 7e

- **Speaker Check:** The system will circulate a test signal to determine which channels have a speaker connected. During this test, you will see the name of each channel position displayed while a signal is sent to that speaker.

**NOTE:** While this test detects whether a speaker is connected to a particular output, it cannot determine whether the speaker is in the correct position. (For example, it can tell whether a speaker is connected to the Surround Right output, but it cannot tell whether the speaker is on the right or left side of your listening room.) For that reason, we strongly recommend that you try to listen as the tone circulates, matching the name shown for each channel to the location of the speaker. If a tone is heard from a speaker position that does not match the on-screen message, stop EzSet/EQ, exit the

menus, turn your receiver off and check for proper speaker connections on the rear panel before resuming the setup. When this test is complete, **YES** will be shown to the right of **SPEAKER CHECK** on the menu screen.

- **Speaker Delay:** This test will circulate the tones again as the name of each channel is shown to measure the distance from the microphone to each speaker. The results of these tests will be used to set the delay time settings for each active speaker position. When this test is complete, a speaker-to-microphone (listening position) distance will be shown to the right of **SPEAKER DELAY** line on the menu screen.
- **Speaker Level:** This test circulates a test signal and measures the output from each active speaker position. The results of the measurements are used to adjust the individual channel outputs as needed, so that they are identical. This is an essential element of ensuring that surround sound fields are properly reproduced. If desired, you may use the results of the automated testing as a baseline and then make manual adjustments to trim the output levels to your personal taste, following the instructions shown on page 23-27. When this test is complete, an output level adjustment number will be shown to the right of **SPEAKER LEVEL** line on the menu screen.
- **Speaker Size:** The measurements and calculations for this test take place at the same time as the test signals are circulated to calculate the output levels, and they are used to determine whether the speakers in your system are "large" or "small" for the purposes of bass management. (If desired, you may use the results of the automated testing as a baseline and then make manual adjustments to the speaker size settings on a source-independent basis, following the instructions shown on page 23-27.) When this test is complete, an output level adjustment number will be shown to the right of the **SPEAKER SIZE** line on the menu screen.
- **Speaker Crossover:** The measurements and calculations for this test take place at the same time as the test signal is circulated to calculate the levels, and they are used to determine the crossover setting for each speaker in your system to create a seamless transition between the frequencies sent to your main speakers and subwoofer (if available). If desired, you may use the results of the automated testing as a baseline and then make manual adjustments to the crossover settings on a source-independent basis, following the instructions shown on page 23-27. When this test is complete, a crossover frequency will be shown to the right of the **SPEAKER X-OVER** line on the menu screen.

## System Configuration

- **Room Equalization:** Each room has unique characteristics that may affect the frequency response at the listening position. For example, doorways and alcoves can increase bass response nearby. Varying surfaces such as hard floors or windows, or soft carpets or draperies, may also affect the way the room responds to sound. Until now, expensive testing devices and long hours of taking measurements and adjusting room furnishings were required in order to smooth out the frequency response to avoid artifacts. EzSet/EQ simplifies equalization, delivering world-class performance without the extra expense. While the test tone circulates, EzSet/EQ is able to obtain a sonic "view" of the room and its characteristics, and adjust the receiver's output accordingly to customize performance to the listening room.

**Step 9:** When all measurements are successfully completed, the test signals will stop and a **TEST DONE - UNPLUG MIC** message will appear in the second line of the on-screen menu listings.

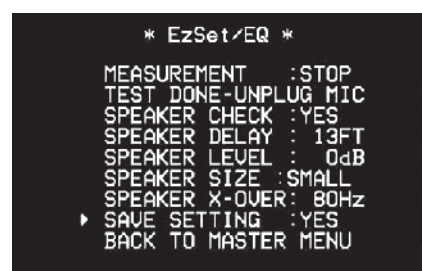

Figure 7f

Unplug the microphone and store it in a safe place so that it is available to recalibrate your system if needed due to a change in speakers, preferred listening position, or a major change in the room's furnishings (such as the addition of thick carpeting or plush furniture) that might require different settings. To enter the settings to the receiver's memory and return to the Master Menu, press the **▲/▼ Navigation Buttons 14** so that the on-screen cursor is pointing to **RETURN TO MASTER MENU** and press the **Set Button 16**.

**Note:** If you wish to check the test results before exiting the EzSet/EQ menu, press the **▲/▼ Navigation Buttons 14** so that the on-screen cursor is at the second line of the menu listings, and then press the **◀▶ Navigation Buttons 15 37** to scroll through the list of speaker positions. The data on each line will also be entered into the listings on the individual **SPEAKER SETUP**, **DELAY ADJUST** and **CHANNEL ADJUST** menus once you exit **EZSET/EQ**.

**Step 10:** If the measurements are not successful due to a missing or malfunctioning speaker, an **ERROR** message and menu will appear, as shown in Figure 7g. The EzSet/EQ system is programmed to look for speaker pairs at the front left/front right, surround left/surround right and surround back left/surround back right positions. If the tests to any of those three channel pairs indicates that one, but not both of the speakers in the pair is present, the menu will show **NONE** next to the speaker position where the tests did not report back that a speaker is present. Should this message appear, make note of the suspect speaker location, exit all menus and turn the receiver off. Check all speaker wire connections and then rerun EzSet/EQ.

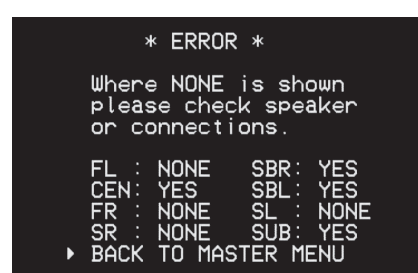

Figure 7g

When you have successfully completed the EzSet/EQ process and made any needed adjustments to the input and surround mode configurations, your receiver is ready for use. If you do not wish to make any manual adjustments to the settings, you may skip the rest of this section and proceed to the Basic Operation section of this manual on page 32 to learn how to operate AVR 147. For those situations where you may wish to make a change to the settings entered by EzSet/EQ, follow the instructions on the following pages.

## Manual Setup

Harman Kardon recommends that you use the EzSet/EQ procedure described on pages 21 to configure your receiver for operation. However, you may manually configure your AVR if you simply prefer to make your adjustments manually.

To begin manual setup using the full-OSD menu system, press the **OSD Button 22** so that the **MASTER MENU** appears on screen. Press the **▲/▼ Buttons 14** until the **▶** cursor points to the **MANUAL SETUP** line, and press the **Set Button 16**. The **MANUAL SETUP** menu (Figure 8) will appear.

With the **MASTER MENU** on screen, press the **▼ Button 14** until the **▶** cursor is pointing to the **MANUAL SETUP** line, and press the **Set Button 16**. The **MANUAL SETUP** submenu will appear (see Figure 8).

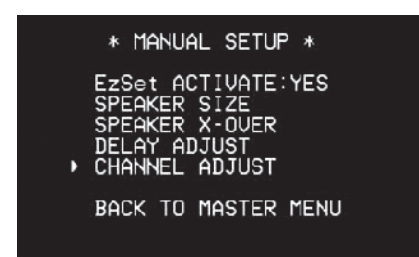

Figure 8

Adjust the submenus in the **MANUAL SETUP** submenu in order, as some settings require that previous settings be established first.

**EzSet ACTIVATE:** The first line in the Manual Setup menu indicates whether you have run EzSet/EQ and whether the settings obtained by EzSet/EQ have been activated as the starting point for manual setup. If you have run EzSet/EQ but you wish to start the setup process from scratch, use the **▲/▼ Navigation Buttons 14** to move the cursor to this line, and then use the **◀▶ Navigation Buttons 15 37** to change the setting to **N 0**.

The next four lines of the Manual Setup menu are used to access the four submenus used during the setup process. Each submenu's settings are dependent upon the previous submenu, and therefore we recommend you visit the menus in the order shown.

### Speaker Setup

This menu tells the AVR which type of speakers are in use. This is important as it determines which speakers receive low-frequency (bass) information.

For each of these settings use the **LARGE** setting if the speakers for a particular position are traditional full-range loudspeakers that are capable of reproducing sounds below 100Hz. Use the **SMALL** setting for smaller, frequency-limited satellite speakers that do not reproduce sounds below 100Hz. Note that when "small"



## System Configuration

speakers are used, a subwoofer is required to reproduce low-frequency sounds. Remember that the "large" and "small" descriptions do not refer to the actual physical size of the speakers, but to their ability to reproduce low-frequency sounds. If you are in doubt as to which category describes your speakers, consult the specifications in the speakers' owner's manual, or ask your dealer.

At last, this menu also makes you choose if the speaker setting will be the same for each input source (**GLOBAL**), or will be set differently for each input (**INDEPENDENT**).

### Notes:

- When "Independent" is selected for the speaker settings (see below), they need to be made for each input individually and you can determine which speaker should be used depending on the input source selected. So it's possible e.g. to turn off the Center and/or the Sub with any music source selected and to use them with any movie input source.
- With the currently selected input all speaker settings will be copied to all other surround modes (as far as speakers are used with them) and need not be repeated when another surround mode is selected with that input.

It is easiest to enter the proper settings for the speaker setup through the **SPEAKER SIZE** menu (Figure 9). So press the **OSD Button 22** to bring up the **MASTER MENU** (Figure 1), and then press the **▼ Button 14** three times so that the cursor is on the **MANUAL SETUP** line.

At this point, press the **Set Button 16** and select the **SPEAKER SIZE** menu (Figure 9).



Figure 9

1. Before you start the speaker setting, you should determine if you want all inputs being configured with the same speaker size setting (**GLOBAL**) or if all inputs should be configured individually (**INDEPENDENT**).

To configure all inputs for "Global" or "Independent" press the **▲ Button 14** twice so that the cursor is next to the **BASS MGR** line.

This setting allows you to use the same speaker configuration for all inputs, or to have different settings for each input. In most cases the factory default setting of **GLOBAL** will be appropriate, as most listeners do not need to have

individualized speaker settings. However, some listeners, particularly those with full-range front speakers that are used for both movies and music may prefer that different speaker settings be used when listening to music through a CD player as opposed to a movie from a DVD player, VCR or cable/satellite set top.

If you wish to customize the speaker size individually to each input, make certain that the cursor is on the **BASS MGR** line and press the **◀▶ Buttons 15 37** so that **INDEPENDENT** appears in highlighted video. When this setting is entered all speaker size settings will be shown with their factory default size in the menu and all other inputs will turn to **INDEPENDENT** too. Now you should enter the speaker size settings preferred for the input selected, as described below. Remember that in this case the size settings just entered will apply to the current input **ONLY**, and you will need to go back to the **INPUT** menu to select another input, and then return to this menu page again to change the settings for the next input. Repeat the procedure for any input where you wish to have a set of speaker configuration different from the default settings.

**NOTE:** When the **INDEPENDENT** setting is activated, you may assign different speaker size settings to each input to accommodate different bass management settings that match your preferences with the type of program material normally used with a particular source (for example, when movies are played from DVD and music from a CD player). However, the actual speaker crossover settings are set only once and do not change with the input selection. The reason is that, while bass management preferences may vary, the actual speakers remain the same, regardless of the bass-management and redirection settings.

2. Begin the speaker size setup process by making certain that the cursor is pointing toward the **LEFT/RIGHT** line, which sets the configuration for the front left and right speakers. If you wish to make a change to the front speakers' configuration, press the **◀▶ Buttons 15 37** so that either **LARGE** or **SMALL** appears, matching the appropriate description from the definitions shown above.

When **SMALL** is selected, low-frequency front channel sounds will be sent only to the subwoofer output. If you choose this option and there is no subwoofer connected, you will not hear any low-frequency sounds with front channel signals.

When **LARGE** is selected, a full-range output will be sent to the front left and front right outputs. Depending on the choice made in the **SUBWOOFER** line in this menu (see below), the front left and right bass information may also be directed to the subwoofer.

**NOTE:** When the front speakers are set to the **LARGE** option and the surround mode is set to "Surround Off", or pure two-channel stereo, when an analog signal source is present it will be routed directly from the input to the volume control without being digitized or processed. If you have full-range front speakers and wish to remove all digital processing from the circuit path, select this configuration. If you wish to set this option for use with only one input, such as a CD player that uses an external DAC or an optional, external phono preamp, you must choose the **INDEPENDENT** setting on the **BASS MGR** line at the bottom of this menu so that only those inputs where the analog bypass is desired will be routed in this fashion, while other analog inputs such as a VCR or cable box will be digitized for surround processing.

**Important Note:** When a speaker set with a subwoofer and two front satellites connected to the Sub's speaker outputs is used, the Sub's inputs must be connected to the **Front speaker outputs 14** and **LARGE** must be selected for the front speakers (and **NONE** for the subwoofer, see below).

3. When you have completed your selection for the front channel, press the **▼ Button 14** on the remote to move the cursor to **CENTER**.

4. Press the **◀▶ Buttons 15 37** on the remote to select the option that best describes your center speaker, based on the speaker definitions shown below.

When **SMALL** is selected, low-frequency center channel sounds will be sent to the Fronts, if they are set to **LARGE** and Sub is turned off (see below). When Sub is on, low frequency center channel sounds will be sent to the subwoofer only.

When **LARGE** is selected, a full-range output will be sent to the center speaker output, and **NO** center channel signal will be sent to the subwoofer output (except when the Pro Logic II Music mode is in use).

**NOTE:** If you choose Logic 7 as the surround mode for the particular input source for which you are configuring your speakers, the AVR will not make the **LARGE** option available for the center speaker. This is due to the requirements of Logic 7 processing, and does not indicate a problem with your receiver.

When **NONE** is selected, no signals will be sent to the center-channel output. The receiver will operate in a "phantom" center channel mode. Center-channel information will be sent to the left and right front channel outputs and the center channel bass will be sent to the subwoofer output when **L/R+LFE** is selected in the **SUBWOOFER** line in this menu (see below). This mode is needed if no Center speaker is used. Note that when the Logic 7 Cinema or Enhanced

## System Configuration

surround modes are selected a Center speaker must be used, the Logic 7 Music mode works well without a Center too.

5. When you have completed your selection for the center channel, press the **▼ Button 14** on the remote to move the cursor to **SURROUND**.

6. Press the **◀▶ Buttons 15 37** on the remote to select the option that best describes the surround speakers in your system based on the speaker definitions shown on page 23.

When **SMALL** is selected, with all digital surround modes low-frequency surround channel sounds will be sent to the Fronts when Sub is turned off or to the subwoofer output when Sub is on. With any analog surround mode the rear bass feed depends on the mode selected and the setting of the Sub and front speakers.

When **LARGE** is selected, a full-range output will be sent to the surround channel outputs (with all analog and digital surround modes), and except with Hall and Theater modes, NO surround channel bass will be sent to the subwoofer output.

When **NONE** is selected, surround-sound information will be split between the front left and front right outputs. For optimal performance when no surround speakers are in use, the Dolby 3 Stereo mode should be used.

7. When you have completed your selection for the surround channels, press the **▼ Button 14** on the remote to move the cursor to **SUBWOOFER**.

8. Press the **◀▶ Buttons 15 37** on the remote to select the option that best describes your system.

The choices available for the subwoofer position will depend on the settings for the other speakers, particularly the front left/right positions.

If the front left/right speakers are set to **SMALL**, the subwoofer will automatically be set to **SUB**, which is the "on" position.

If the front left/right speakers are set to **LARGE**, three options are available:

- If no subwoofer is connected to the AVR, press the **◀▶ Buttons 15 37** on the remote so that **NONE** appears in the on-screen menu. When this option is selected, all bass information will be routed to the front left/right "main" speakers.
- If a subwoofer is connected to the AVR, you have the option to have the front left/right "main" speakers reproduce bass frequencies at all times, and have the subwoofer operate only when the AVR is being used with a digital source that contains a dedicated Low Frequency Effects, or LFE soundtrack. This

allows you to use both your main and subwoofer speakers to take advantage of the special bass created for certain movies. To select that option press the **◀▶ Buttons 15 37** on the remote so that **LFE** appears in the on-screen menu.

- If a subwoofer is connected and you wish to use it for bass reproduction in conjunction with the main front left/right speakers, regardless of the type of program source or Surround mode you are listening to, press the **◀▶ Buttons 15 37** on the remote so that **L/R+LFE** appears in the on-screen menu. When this option is selected, a full-range signal will be sent to the front left/right "main" speakers. The subwoofer will receive the front left and right bass frequencies under the crossover frequency selected in another setting on this menu, as described below, and also the LFE soundtrack.

9. When all initial speaker "size" settings have been made, you now have the option to take advantage of the AVR's Triple Crossover system, which allows individual crossover settings to be made for each speaker group. In systems where full-range or tower speakers are used for the front soundstage or where different brands or models are in use at the various speaker positions, this feature allows you to custom tailor the bass management and redirection circuits with a precision not previously possible.

If you have already run EzSet/EQ the settings calculated during that procedure will already appear. No further adjustment is required unless you wish to conform a specific item to your personal taste or a nonstandard system configuration.

The low-frequency crossover point is set by the design of your speakers. It is defined as the frequency which is the lowest possible frequency the speaker is capable of reproducing. Before making any changes to the settings for the crossover point we suggest that you find the crossover point for the speakers in each of the three groupings, front left/right, center front and surrounds by looking at the specifications page of the speaker's owner's manual, by getting that information from the manufacturer's Web site, or by contacting your dealer or the manufacturer's customer service department. You will need this figure to accurately configure the next group of settings.

The factory default setting for all speaker positions is 100Hz. If that setting is acceptable for all channels, then no adjustments are needed and you may skip this section. However, should you wish to change one of the settings, please proceed to the **SPEAKER X - OVER** submenu, as shown in Figure 10.

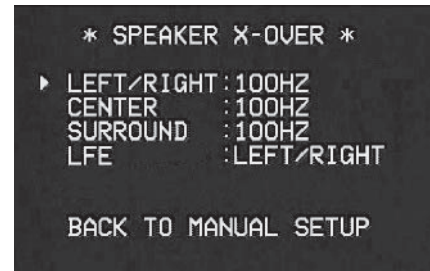

Figure 10

To change the setting for any of the three speaker groups Left/Right, Center or Surround, press the **▲/▼ Buttons 14** until the cursor is next to the line where you wish to make a change and then press the **◀▶ Buttons 15 37** until the desired setting appears. The available choices at which point low-frequency information will be sent to the subwoofer (or to the Front Left/Right speakers in case subwoofer is set to OFF), rather than to the speaker channel, are 40Hz, 60Hz, 80Hz, 100Hz, 120Hz, 150Hz and 200Hz. Pick the choice that is identical to the information for the speakers, or if an exact match is not possible, pick the closest choice that is ABOVE the speaker's low-frequency limit to avoid the creation of a low-frequency "hole" where your system will have no bass information.

In cases where **LARGE** has been selected as the front channel speaker option and **L/R+LFE** has been selected as the subwoofer option, the front channel sound information below the crossover point selected for the L/R front speakers (when fronts are set to "Small") will be sent to BOTH the front channel speakers and the subwoofer.

The crossover settings for the Left/Right, Center and Surround speakers are used to determine where bass information is sent when it is derived from the main channels of a source. The setting for the menu line shown as **LFE** is used to impose a low-pass filter point for the information in the Low Frequency Effects (LFE) channel that is a part of Dolby Digital- and DTS-encoded source material. While the LFE channel, which is the ".1" you see in surround sound designations, is restricted to low frequency sounds, some mixes may include information that is higher in frequency than your subwoofer is capable of reproducing. To prevent unwanted sounds from being sent to subwoofers that cannot handle them and which do not have a built-in low-pass filter, the **LFE** option line enables you to select a setting for the low-pass filter that is part of the subwoofer feed from the LFE channel.

The settings available are the same as those tied to any one of the four available speaker positions on this submenu. We recommend that you use the frequency that is just slightly higher than the upper capability limit of your subwoofer, as shown in the sub's Owner's Manual. When the cursor is on the **LFE** line, press the

## System Configuration

◀▶ **Navigation Buttons 15** to choose the appropriate setting.

Note that the crossover point for the surround speakers and the surround back speakers will be identical. That's why no crossover point for the surround back speakers is selectable or shown in the menu.

**Important Note:** All settings for the crossover points will be "Global", i.e. they will be identical for all inputs no matter if the BASSMANAGER (see above) was configured for "Global" or "Independent".

10. When all speaker selections have been made, press the ▼ **Button 14** until the cursor is next to the **BACK TO MANUAL SETUP** line and press the **Set Button 16** to return to the Manual setup submenu.

11. The Speaker Configuration may also be changed at any time without using the full-OSD on-screen menu system by pressing the **Speaker Selector 6** on the front panel or **38** on the remote control. Once the button is pressed, **FRONT SPEAKER** will appear in both the lower third of the video display and the **Main Information Display 23**.

Within five seconds, either press the ◀▶ buttons **7** on the front panel or the ▲/▼ buttons **14** on the remote to select a different speaker position, or press the **Set Button 12 16** to begin the adjustment process for the front left and right speakers.

When the **Set button 12 16** has been pressed and the system is ready for a change to the front speaker setting, the on-screen display and **Main Information Display 23** will read **FRONT LARGE** or **FRONT SMALL** depending on the current setting. Press the ◀▶ buttons **7** on the front panel or the ▲/▼ buttons **14** on the remote until the desired setting is shown, using the instructions for "large" or "small" shown earlier, then press the **Set button 12 16**.

If another speaker position needs to be changed, press the ◀▶ buttons **7** on the front panel or the ▲/▼ buttons **14** on the remote to select a different speaker position, press the **Set button 12 16** and then the ◀▶ buttons **7** on the front panel or the ▲/▼ buttons **14** on the remote until the correct speaker setting is shown and press the **Set button 12 16** again to confirm the selection.

To assist in making these settings, the icons in the **Speaker/Channel Input Indicators 14** will change as the speaker type is selected at each position. When only the inner icon box is lit, the speaker is set for "small." When the inner box and the two outer boxes with circles inside them are lit, the speaker is set for "large." When no indicator appears at a speaker location, that position is set for "none" or "no" speaker.

**Note:** These icons are available only when making setup changes without the use of the full OSD mode.

As an example, in the Figure below, all speakers are set for "large," and a subwoofer is set.

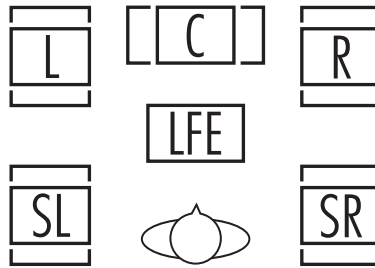

### Delay Settings

Due to the different distances between the listening position for the front channel speakers and the surround speakers, the amount of time it takes for sound to reach your ears from the front or surround speakers is different. You may compensate for this difference through the use of the delay settings to adjust the timing for the specific speaker placement and acoustic conditions in your listening room or home theater.

To change the settings, follow the instructions below to enter the distance between the speaker's location and your main listening position. The measurements need not be accurate to the inch, as the system is designed to accommodate typical listening rather than a specific "sweet spot" position.

In addition to adjusting the delay time for each individual speaker position, the AVR is among the few A/V receivers that allows you to adjust the delay for the combined output of all speakers as a group. This feature is called A/V Sync Delay; it allows you to compensate for delays to the video image that may be caused by the processing in products such as digital video displays, video scalars, digital cable or satellite systems, or personal video recorders. With proper adjustment of the setting for A/V Sync Delay, you can eliminate the loss of lip sync that may be caused by digital video applications.

The setting for A/V Sync Delay may only be done manually, since it requires that you observe the program material on your video display while adjusting the delay, if any, required for the specific source. The A/V Sync Delay should still be configured as outlined below.

To re-synchronize the front, center and surround channels at first measure and note the distance from the listening/viewing position to the front, center and surround (if any) speakers in meters.

Due to the differences in the way each surround mode operates, the delay settings must be established individually for each surround mode. However, once the delay settings are configured for the version of the surround mode with the

most channels, they need not be entered again for a version of that mode with fewer channels. However, you will need to enter the delay settings separately for each variant mode, such as Dolby Pro Logic II – Music, Dolby Pro Logic II – Game, Dolby Pro Logic, Dolby 3 Stereo.

Delay times are adjustable for all surround modes. Although all channels will appear on screen with the default or previously entered distances, the menu system will only allow you to adjust the settings for those channels which are actually used by the current surround mode. For example, when you are listening to music CDs using the CD input in DSP Surround Off mode, you may adjust the delay settings for the front left, front right and subwoofer channels only. The cursor will simply skip the other channels as you navigate through the menu. Therefore, the first time you adjust the delay settings, it is recommended that you select a 5.1-channel surround mode. For the purposes of setting the delay distances, the Logic 7 modes allow access to the settings for all channels without requiring that you play a source.

To start with the delay settings at first select the **DELAY ADJUST MENU** (Figure 11). If the system is not already at that point, press the **OSD button 22** to bring up the master menu. Press the ▼ **Button 14** three times or until the on-screen → cursor is pointing at the **MANUAL SETUP** line. Press the **Set Button 16** and call up the **DELAY ADJUST** submenu.

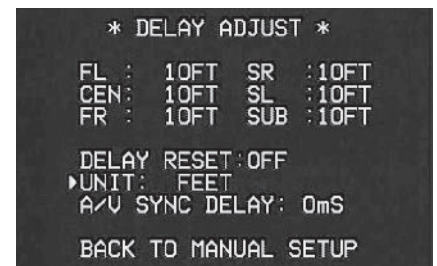

Figure 11

Next move the → cursor to the **UNIT** line and select the unit for distances you prefer to enter, feet or meter. Then move the → cursor to the **FL** line where the first adjustment is made. Now press the ◀▶ **Buttons 15 37** until the distance from the front left speaker to the preferred listening position is entered. Next press the ▼ **Button 14** once to move to the next line.

Now the → cursor will be at the **CEN** line so that the delay for the center speaker may be set. Press the ◀▶ **Buttons 15 37** until the distance from the main listening position to the center speaker is entered.

Repeat the procedure for all active speaker positions by pressing the ▼ **Button 14** again and use the ◀▶ **Buttons 15 37** to change the setting. Remember that this last adjustment will only be needed when you have surround back



## System Configuration

speakers installed and Dolby Digital chosen as the surround mode.

When the delay time for all speaker positions has been set you may return to the master menu by pressing the **▲/▼ Navigation Button 14** until the **→** cursor is pointing to **BACK TO MASTER MENU** and then pressing the **Set Button 16**.

However, if you have a digital video source or a digital video display that causes lack of lip sync you may use the A/V Sync adjust feature to delay the audio signal as it is sent to all channels (as opposed to the individual settings) so that the picture and sound are brought back together. We recommend that this adjustment be made using the direct access controls on the remote, as shown below. That enables you to see the image while making the adjustment; however, you may also adjust it here using the menu system.

To adjust the A/V Sync delay, press the **▲/▼ Navigation Button 14** so that the **→** cursor is pointing to the A/V Sync Delay line on the menu and then press the **◀/▶ Navigation Button 15 37** to delay the sound sufficiently so that it matches the on-screen video.

The delay settings may be adjusted at any time using the remote control and while viewing an on-screen image by pressing the **Delay Select Button 36**. The A/V Sync Delay setting is first, and it may be adjusted by pressing the **Set Button 16** within five seconds of when the **A/V SYNC DELAY** message appears in the on-screen display and the **Lower Display Line 29**. Then, press the **◀/▶ Navigation Button 15 37** to enter the desired delay setting that brings the video and sound back in sync. Press the **Set Button 16** again to enter the setting.

Note that the A/V Sync delay setting is unique to each video input source, so you may enter a different setting to compensate for the differences between any product attached to the Video 1, 2 or 3 inputs.

To change one of the individual speaker positions directly, press the **Delay Select Button 36**, followed by the **▲/▼ Navigation Button 14** to select the desired position as that name appears in the on-screen display and the **Main Information Display 23**. When the name of the speaker position to be adjusted appears press the **Set Button 16** within five seconds. Press the **◀/▶ Navigation Button 15 37** to enter the desired delay setting for that speaker and then press the **Set Button 16** to enter the setting. The **▲/▼ Navigation Button 14** may be used to select another position, or you may simply wait five seconds for the system to time out and return to normal operation.

The delay settings may be adjusted at any time using the remote control and while viewing an on-screen image by pressing the **Delay Select Button 36**.

To change one of the individual speaker positions directly, press the **Delay Select Button 36**, followed by the **▲/▼ Navigation Button 14** to select the desired position as that name appears in the on-screen display and the **Lower Display Line 23**. When the name of the speaker position to be adjusted appears press the **Set Button 16** within five seconds. Press the **◀/▶ Navigation Button 15 37** to enter the desired delay setting for that speaker and then press the **Set Button 16** to enter the setting. The **▲/▼ Navigation Button 14** may be used to select another position, or you may simply wait five seconds for the system to time out and return to normal operation.

### Output Level Adjustment

Output level adjustment is a key part of the configuration of any surround-sound product. It is particularly important for a digital receiver such as the AVR, as correct outputs ensure that you hear sound tracks with the proper directionality and intensity.

**NOTE:** Listeners are often confused about the operation of the surround channels. While some assume that sound should always be coming from each speaker, most of the time there will be little or no sound in the surround channels. This is because they are only used when a movie director or sound mixer specifically places sound there to create ambience, a special effect or to continue action from the front of the room to the rear. When the output levels are properly set, it is normal for surround speakers to operate only occasionally.

Artificially increasing the volume to the rear speakers may destroy the illusion of an enveloping sound field that duplicates the way you hear sound in a movie theater or concert hall.

If you have already calibrated your system using EzSet/EQ the output level adjustments shown will reflect the results of the measurements made by EzSet/EQ. No further changes are needed unless you wish to change a specific item to reflect your personal taste or a non-standard system configuration.

**IMPORTANT NOTE:** The output level can be adjusted for each digital and analog surround mode individually. This allows you to compensate for level differences between speakers, that may also vary with the surround mode selected, or to increase or decrease the level of certain speakers intentionally, depending on the surround mode selected. Note that adjustments made for any surround mode are effective with all inputs associated with the same surround mode.

Before beginning the output level adjustment process, make certain that all speaker connections have been properly made. The system volume should be turned down at first.

For the easiest set-up, follow these steps while seated in the listening position that will be used most often:

1. Make certain that all speaker positions have been properly configured for their "large" or "small" settings (as outlined above) and turn off the OSD system if it is in use.
2. Adjust the volume so that it is at **-1.5**, as shown in the on-screen display or **Main Information Display 23**.
3. Select any input associated with the surround mode for which you want to adjust the output levels. Remember that the same adjustments must be made with all other surround modes you've in use.
4. Manual output level adjustment is most easily done through the **CHANNEL ADJUST** menu (Figure 12). If you are already at the main menu, press the **▼ Button 14** until the on-screen **→** cursor is next to the **MANUAL SETUP** line. If you are not at the main menu, press the **OSD Button 22** to bring up the **MASTER MENU** (Figure 1), and then press the **▼ Button 14** three times so that the on-screen **→** cursor is next to the **MANUAL SETUP** line. Press the **Set Button 16** to bring the **MANUAL SETUP** menu (Figure 8) to the screen, and then scroll down until the **→** cursor is pointing at the **CHANNEL ADJUST** line and press the **Set Button 16**.

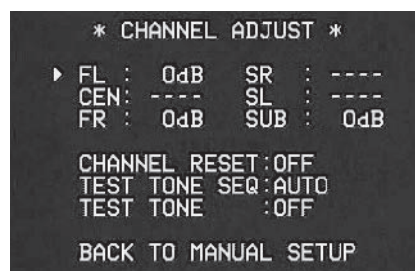

Figure 12

When the **CHANNEL ADJUST** menu first appears, the test tone is off. Use the **▲/▼ Navigation Button 14** to select any channel for adjustment using an external source, such as a test disc, from which to judge the output levels. After the **→** cursor is pointing to the channel to be adjusted, press the **◀/▶ Navigation Button 15 37** to raise or lower the output level. However, before proceeding with any manual adjustment we recommend that you first use the AVR's internal test tone generator and automatic sequencer to send a tone to each channel so that you may verify that all speaker connections have been properly made.

## System Configuration

5. To turn the test tone on and have it automatically circulate among the channels where a speaker has previously been configured (see page 21), press the ▲/▼ **Navigation Button 14** until the → cursor is pointing to the **TEST TONE SEQ** line on the menu. Next, press the ◀▶ **Navigation Button 15 37** until **AUTO** is shown. At this time the test tone will immediately begin to circulate clockwise around the room, playing for two seconds in each speaker before switching to the next speaker position. The → cursor will blink next to the active speaker to indicate which speaker the sound should be coming from.

**IMPORTANT NOTE:** Because this test noise will have a much lower level than normal music, the volume must be lowered after the adjustment for all channels is made, but BEFORE you return to the main menu and the test tone turns off.

**NOTE:** Remember to verify that the speakers have been properly connected. As the test noise circulates, listen to make certain that the sound comes from the speaker position shown in the **Main Information Display 23**. If the sound comes from a speaker location that does NOT match the position indicated in the display, turn the AVR off using the **Main Power Switch 1** and check the speaker wiring or connections to external power amplifiers to make certain that each speaker is connected to the correct output terminal.

6. After checking for speaker placement, let the test noise circulate again, and listen to see which channels sound louder than the others. Using the front left speaker as a reference, press the ◀▶ **Buttons 15 37** on the remote to bring all speakers to the same volume level. When one of the ◀▶ buttons is pushed, the test noise circulation will pause on the channel being adjusted to give you time to make the adjustment. When you release the button, the circulation will resume after five seconds. The on-screen cursor → and the test noise can also be moved directly to the speaker to be adjusted by pressing the ▲/▼ buttons **14** on the remote.

7. Continue to adjust the individual channels until the volume level sounds the same from each speaker. Note that adjustments should be made with the ◀▶ **Buttons 15 37** on the remote only, NOT the main volume controls.

If you are using a sound-pressure level (SPL) meter for precise level adjustment with the test tone, open the main **Volume Control 40** to -15dB and set the individual output level for each channel so that the meter reads 75dB, C-Weighted Slow. After all settings are made turn the main volume down.

You may also make these same adjustments with complete manual control over the channel being adjusted by pressing the ▲/▼ **Navigation Button 14** until the → cursor is pointing to the **TEST TONE SEQ** line on the menu and then using the ◀▶ **Navigation Button 15 37** to select **MANUAL** in the highlighted video. In the **MANUAL** mode, the test tone will also start immediately, but the tone will only be moved to another channel by pressing the ▲/▼ **Navigation Button 14**. When the manual sequencing mode is active, the tone is turned off by pressing the ▲/▼ **Navigation Button 14** until the → cursor is pointing to the **TEST TONE** line and the ◀▶ **Navigation Button 15 37** is then pressed to select **OFF** in the highlighted video.

If you find that the output levels are either uncomfortably low or high, you may repeat the procedure. Return to Step 2 and adjust the master volume either slightly higher or lower to accommodate your particular room layout and your tastes. You may repeat this procedure as many times as necessary to achieve a desired result. In order to prevent possible damage to your hearing or your equipment, we emphasize that you should avoid setting the master volume above 0dB.

When all channels have an equal volume level, the adjustment is complete. Use the ▲/▼ **Buttons 14** to move the → cursor next to the **TEST TONE** line, and press the ◀▶ **Buttons 15 37** until the word **OFF** appears to stop the test tone.

Note that any time a given surround mode is selected, even for a different source input, these output level settings will be used. However, the output levels must be set independently for each surround mode, including variations such as Dolby Pro Logic II-Movie versus Dolby Pro Logic II-Music. Although this may seem to be tedious, it is necessary in order to optimize the AVR's performance when differing methods are employed to steer the audio materials to the various channels. However, the AVR will carry over the settings for one mode to the same mode in a different channel configuration, such as Dolby Pro Logic II-Movie and Dolby Pro Logic II-Movie. If you wish, as a shortcut to get started quickly, you may set the levels for Dolby Pro Logic II-Movie and copy down those settings, reentering them for each of the Dolby modes and entering the settings only for those speakers which are available for each mode. Later, it is recommended that you adjust the output lev-

els while listening to various sources, as opposed to the test tone. See page 38 for more information on trimming the output levels to external source material.

**NOTE:** The subwoofer output level is not adjustable using the test tone. To change the subwoofer level, follow the steps for Output Level Trim Adjustment on page 38.

When all channels have an equal volume level, the adjustment is complete. Now turn the **Volume 40** down to about -40dB, otherwise the listening level may be too high as soon as the source's music starts to play. To exit this menu, press the ▲/▼ buttons **14** until the on-screen ▶ cursor is next to the **BACK TO MASTER MENU** line, and then press the **Set Button 16** to return to the **MASTER MENU**.

The output levels may also be adjusted at any time using the remote control and semi-OSD system. To adjust the output levels in this fashion, press the **Test Button 9**. As soon as the button is pressed, the test tone will begin to circulate as indicated earlier. The correct channel from which the test noise should be heard will be shown in the lower third of the video screen and in the **Main Information Display 23**. While the test noise is circulating, the proper channel position will also be indicated in the **Speaker/Channel Input Indicators 14** by a blinking letter within the correct channel. Turn up the **Volume 40** until you can hear the test noise clearly.

To adjust the output level, press the ▲/▼ **buttons 14** until the desired level is shown in the display or on screen. Once the buttons are released, the test noise will begin to circulate again in five seconds.

When all channels have the same output level, turn the **Volume 40** down to about -40dB, otherwise the listening level may be too high as soon as the source's music starts to play. Afterwards press the **Test Tone Selector 9** button again to turn the test tone off and complete the process.

**IMPORTANT NOTE:** The Output level adjustment made will be effective for all inputs, but only for the actual surround mode selected. To be effective for any other mode select that mode (with any input) and repeat the level adjustment described above. This will also allow you to compensate level differences between speakers, that may be different with each surround mode, or to increase or decrease the level of certain speakers intentionally, depending on the surround mode selected.



## System Configuration

After one input has been adjusted for analog or digital input, speaker type and surround mode, return to the **INPUT SETUP** line on the **MASTER** menu and enter the settings for each input that you will use. In most cases, only the digital input and surround mode may be different from one input to the next, while the speaker type will usually be the same (inputs set to **GLOBAL**). But if preferred you can also select different speaker types or turn speakers on or off individually for each input in use.

Once the settings outlined on the previous pages have been made, the AVR is ready for operation. While there are some additional settings to be made, these are best done after you have had an opportunity to listen to a variety of sources and different kinds of program material. These system settings are described on pages 39 to 40 of this manual. In addition, any of the settings made in the initial configuration of the unit may be changed at any time. As you add new or different sources or speakers, or if you wish to change a setting to better reflect your listening taste, simply follow the instructions for changing the settings for that parameter as shown in this section.

Note that any settings changed at any time, also when the discrete buttons are used only, will be stored in memory in the AVR, also if it's turned off completely, unless it will be reset (see page 45).

Having completed the setup and configuration process for your AVR, you are about to experience the finest in music and home-theater listening. Enjoy!

# Operation

## Surround Mode Chart

MODE	FEATURES
DOLBY DIGITAL	Available only with digital input sources encoded with Dolby Digital data. It provides up to five separate main audio channels and a special dedicated Low Frequency Effects channel.
DTS 5.1	When the speaker configuration is set for 5.1-channel operation, the DTS 5.1 mode is available when DVD, audio-only music or laserdiscs encoded with DTS data are played. DTS 5.1 provides up to five separate main audio channels and a special dedicated low-frequency channel.
DOLBY PRO LOGIC II MOVIE MUSIC DOLBY PRO LOGIC GAME	Dolby Pro Logic II is the latest version of Dolby Laboratory's benchmark surround technology that decodes full-range, discrete left, center right, right surround and left surround channels from matrix surround encoded programs and conventional stereo sources when an analog input or a digital input with PCM or Dolby Digital 2.0 recordings is in use. The Dolby Pro Logic II Movie mode is optimized for movie soundtracks that are recorded with matrix surround, by creating separate center, rear left and rear right signals. While the Pro Logic II Music mode should be used with musical selections that are recorded with matrix surround or even with normal stereo mode, creating separate rear left and rear right signals in any case. The Pro Logic II mode creates compelling five-channel surround sound from conventional stereo recordings. Game mode ensures that special effects are routed to the surround channels, while delivering their full impact using the subwoofer, thus fully immersing the game player in the universe of the video game.
Logic 7 Cinema Logic 7 Music	Exclusive to Harman Kardon for AV receivers, Logic 7 is an advanced mode that extracts the maximum surround information from either surround-encoded programs or conventional stereo material. Depending on the number of speakers in use and the selection made in the <b>SURROUND SELECT</b> menu, the "5.1" versions of Logic 7 modes are available when the 5.1 option is chosen. The Logic 7 C (or Cinema) mode should be used with any source that contains Dolby Surround or similar matrix encoding. Logic 7 C delivers increased center-channel intelligibility, and more accurate placement of sounds with fades and pans that are much smoother and more realistic than with former decoding techniques. The Logic 7 M or Music mode should be used with analog or PCM stereo sources. Logic 7 M enhances the listening experience by presenting a wider front soundstage and greater rear ambience. Both Logic 7 modes also direct low-frequency information to the subwoofer (if installed and configured) to deliver maximum bass impact.

# Operation

## Surround Mode Chart

MODE	FEATURES
DTS Neo:6 Cinema DTS Neo:6 Music	<p>These two modes are available when any analog source is playing to create a multi-channel surround presentation from conventional Matrix-encoded and traditional Stereo sources. Select the Cinema version of Neo:6 when a program with any type of analog Matrix surround encoding is present. Select the Music version of Neo:6 for optimal processing when a nonencoded, two-channel stereo program is being played.</p> <p>When selecting a DTS Neo:6 Cinema mode, a 3- or 5-channel configuration may be available, depending on the number of speakers in your system. Use 3-channel mode when only a front left and right and a center speaker are present; surround-channel information will be mixed into these speakers. The 5-channel mode will only be available if you have configured your surround speakers as active.</p>
DTS 96/24	<p>DTS 96/24 is a high-resolution format that uses a 96kHz sampling rate with 24 bits to produce extended information that improves the harmonics of the source material. The AVR is capable of automatically detecting and decoding DTS 96/24 materials and delivering them as the artist intended.</p>
Dolby 3 Stereo	<p>Uses the information contained in a surround-encoded or two-channel stereo program to create center-channel information. In addition, the information that is normally sent to the rear-channel surround speakers is carefully mixed in with the front-left and front-right channels for increased realism.</p> <p>Use this mode when you have a center channel speaker but no surround speakers.</p>
Dolby Virtual Speaker Reference Wide	<p>Dolby Virtual Speaker technology uses a next-generation advanced algorithm to reproduce the dynamics and surround sound effects of a precisely placed 5.1-channel speaker system using only front left and right speakers. In the Reference Mode, the apparent width of the sound across the front image is defined by the distance between the two speakers. The Wide Mode provides a wider, more spacious front image when the two speakers are close together.</p>
THEATER	<p>The THEATER mode creates a sound field that resembles the acoustic feeling of a standard live performance theater, with stereo and even pure mono sources.</p>
HALL 1 HALL 2	<p>The two Hall modes create sound fields that resemble a small (HALL 1) or medium sized (HALL 2) concert hall, with stereo and even pure mono sources.</p>
5-Channel Stereo	<p>This mode takes advantage of multiple speakers to place a stereo signal at both the front and back of a room. Depending on whether the AVR has been configured for either 5.1 operation, one of these modes, but not both, is available at any time. Ideal for playing music in situations such as a party, this mode places the same signal at the front-left and surround-left, and at the front-right and surround-right speakers. The center channel is fed a summed mono mix of the in-phase material of the left and right channels.</p>
Surround Off (Stereo) Surround Off (Bypass) DSP Surround Off	<p>These modes turn off all surround processing and present the pure left- and right-channel presentation of two-channel stereo programs. The Surround Off (Bypass) mode may only be used with analog source inputs, as it preserves the analog format of the audio signal for its entire path of travel through the receiver to the speaker and subwoofer outputs, bypassing all digital processing. Digital bass management is not available in Surround Off mode. The DSP Surround Off mode can be used with either an analog or digital input, as the signal undergoes digital bass management to optimize the distribution of the low frequencies between the main speakers and a subwoofer.</p>
Dolby Headphone DH	<p>Dolby Headphone enables ordinary stereo headphones to portray the sound of a five-speaker surround-playback system.</p>

# Operation

## Basic Operation

Once you have completed the setup and configuration of the AVR, it is simple to operate and enjoy. The following instructions should be followed for you to maximize your enjoyment of your new receiver:

### Turning the AVR On or Off

- When using the AVR for the first time, you must press the **Main Power Switch 1** on the front panel to turn the unit on. This places the unit in a Standby mode, as indicated by the amber color of the **Power Indicator 3**. Once the unit is in Standby, you may begin a listening session by pressing the **System Power Control 2** or the **Source** button **15** on the front panel or the **AVR Selector 6**. Note that the **Power Indicator 3** will turn blue. This will turn the unit on and return it to the input source that was last used. The unit may also be turned on from Standby by pressing any of the **Source Selector** buttons on the remote **5 6 7 8** or the **Source** button **15** on the front panel.

**NOTE:** After pressing one of the **Input Selector** buttons **5** (except VID3) to turn the unit on, press the **AVR Selector 6** to have the remote control the AVR functions.

To turn the unit off at the end of a listening session, simply press the **System Power Control 2** on the front panel or the **Power Off Button 4** on the remote. Power will be shut off to any equipment plugged into the rear panel **Switched AC Outlets 17** and the **Power Indicator 3** will turn orange.

When the remote is used to turn the unit "off" it is actually placing the system in a Standby mode, as indicated by the orange color of the **Power Indicator 3**.

When you will be away from home for an extended period of time it is always a good idea to completely turn the unit off with the front panel **Main Power Switch 1**.

**NOTE:** All preset memories may be lost if the unit is left turned off with the **Main Power Switch 1** for more than two weeks.

### Using the Sleep Timer

- To program the AVR for automatic turn-off, press the **Sleep Button 10** on the remote. Each press of the button will increase the time before shut down in the following sequence:

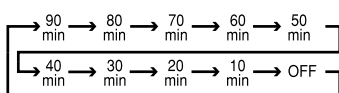

The sleep time will be displayed in the **Main Information Display 23** and it will count down until the time has elapsed.

When the programmed sleep time has elapsed, the unit will automatically turn off (to Standby mode). Note that the front panel display will dim to one half brightness when the Sleep function is programmed. To cancel the Sleep function, press and hold the **Sleep Button 10** until the information display returns to normal brightness and the Sleep indicator numbers disappear and the words **SLEEP OFF** appear in the **Main Information Display 23**.

## Source Selection

- To select a source, press any of the **Source Selector** buttons on the remote **5 7 8**.

**NOTE:** After pressing one of the **Input Selector** buttons **5** to turn the unit on, press the **AVR Selector 6** to have the remote control the AVR functions.

- The input source may also be changed by pressing the front-panel **Input Source Selector** button **15**. Each press of the button will move the input selection through the list of available inputs.

- As the input is changed, the AVR will automatically switch to the digital input (if selected), surround mode and speaker configuration that were entered during the configuration process for that source.

- The front-panel **Video 3 Inputs 21**, **Optical Digital 3 Input 13** or the **Coaxial Digital 3 Input 20** may be used to connect a device such as a video game or camcorder to your home entertainment system on a temporary basis.

- As the input source is changed, the new input name will appear momentarily as an on-screen display in the lower third of the video display. The input name will also appear in the **Main Information Display 23** and a blue LED will light next to the selected input's name in the front-panel **Input Indicators 22**.

- When a pure audio input (CD, Tuner, Tape, 6-Channel Input) is selected, the last video input used remains routed to the **Video Outputs 26** and **Video Monitor Output 12**. This permits simultaneous viewing and listening to different sources.

- When the **Bridge** Digital Media Player (DMP) source is selected, if a compatible Apple iPod device is inserted in an optional Harman Kardon **Bridge** that is connected to the **Bridge** DMP **Connector 9** on the rear panel, function messages will appear on any video display connected to the AVR's **Video Monitor Outputs 12**, and the remote control may be used to navigate the iPod and access many of its functions.

The function messages will also appear in the front-panel display, and the iPod's battery may be charged. See the owner's guides for the **Bridge** and your iPod for more information.

- When a Video source is selected, its audio signal will be fed to the speakers and the video signal for that input will be routed to the appropriate **Monitor Output Jack 12** and will be viewable on a TV monitor connected to the AVR. If a component video source is connected to the **Video 1 2, Video 2 20 Component Inputs**, it will be routed to the **Component Video Outputs 21**. Make certain that your TV is set to the proper input to view the appropriate video signal (composite, S-Video or component video, see Notes for S-Video on page 14).

## 6-Channel Direct Input

The **6 CHANNEL DIRECT INPUT** should be used when the input source device has its own internal bass management system. This input passes the input from the source directly through to the volume control without any analog to digital conversion and it mutes the unused input jacks to prevent unwanted noise from interfering with system performance.

Note that when the 6-Channel Direct Input is in use, you may not select a surround mode, as the external decoder determines the processing in use. In addition, there is no signal at the record outputs or bass management when the 6-Channel Direct Input is in use and the tone or balance controls will not function.

## Controls and Use of Headphones

- Adjust the volume to a comfortable level using the front panel **Volume Control 27** or remote **Volume Up/Down 40** buttons.

- To temporarily silence all speaker outputs press the **Mute** button **39**. This will interrupt the output to all speakers and the headphone jack, but it will not affect any recording or dubbing that may be in progress. When the system is muted, the word **MUTE** will blink in the **Main Information Display 23**. Press the **Mute** button **39** again to return to normal operation.

- To set the output of the AVR so that the output is "flat," with the tone and balance controls deactivated, press the **Tone Mode** button **8** once or twice so that the words **Tone Off** appear momentarily in the **Main Information Display 23**. To return the tone controls to an active condition, press the **Tone Mode 8** button once or twice so that the words **Tone In** momentarily appear in the **Main Information Display 23**.

- For private listening, plug the 6.3 mm stereo phone plug from a pair of stereo headphones into the front panel **Headphone Jack 4**. Note that when the headphone's plug is connected, the word **DOLBY H:BP** will scroll once across

## Operation

the **Main Information Display** **23** and all speakers will be silenced. When the headphone plug is removed, the audio feed to the speakers will be restored.

- When the headphones are in use, you may take advantage of the Dolby Headphone modes to bring added spaciousness to headphone listening. Press the **Dolby Mode Select Button** **23** or the **Surround Mode Group Selector** **5** to cycle through the three Dolby Headphone modes to select the one that you prefer.

### Surround Mode Selection

One of the most important features of the AVR 147 is its ability to reproduce a full multi-channel surround sound field from digital sources, analog matrix surround encoded programs and standard stereo or even mono programs.

Selection of a surround mode is based on personal taste, as well as the type of program source material being used. For example, CDs, motion pictures or TV programs bearing the logo of one of the major surround-encoding processes, such as Dolby Surround should be played in either the Dolby Pro Logic II Movie (with movies) or Music (with music) surround mode, with any DTS NEO:6 mode or with Harman Kardon's exclusive Logic 7 Movie Mode, to create a full range 5.1 channel surround signal from surround encoded programs, with a stereophonic left and right rear signal, just as it was recorded (e.g. sound being recorded from left rear side will be heard from that side only, for more details see chart on page 30-31).

Note that when Dolby Digital 2.0 signals (e.g. "D.D. 2.0" tracks from DVD), that are encoded with Dolby Pro Logic information, are received via any digital input, the Dolby Pro Logic II Movie mode will be selected automatically (in addition to the Dolby Digital mode) and will decode a full range 5.1 channel surround sound even from those recordings (see also "Dolby Digital" on this page).

To create wide, enveloping sound field environments and defined pans and flyovers with all analog stereo recordings select the Dolby Pro Logic II Music or Emulation mode or Harman Kardon's exclusive Logic 7 Music mode for a dramatic improvement in comparison to the Dolby Pro Logic (I) mode of former times.

**NOTE:** Once a program has been encoded with matrix surround information, it retains the surround information as long as the program is broadcast in stereo. Thus, movies with surround sound may be decoded via any of the analog surround modes such as Pro Logic II Cinema, Logic 7 Cinema or DTS Neo:6 Cinema, when they are broadcast via conventional TV stations, cable, pay-TV and satellite transmission. In addition, a

growing number of made-for-television programs, sports broadcasts, radio dramas and music CDs are also recorded in surround sound.

You may view a list of these programs at the Dolby Laboratories Web site at [www.dolby.com](http://www.dolby.com)

Even when a program is not listed as carrying intentional surround information, you may find that the Dolby Pro Logic II Music, DTS NEO:6 Music or Logic 7 Music or Enhanced modes often deliver enveloping surround presentations through the use of the natural surround information present in all stereo recordings.

However, for stereo programs without any surround information the Theater, Hall and 5CH Stereo modes should be tried (effective particularly with old "extreme" stereo recordings) and for mono programs, we suggest that you try the Theater or Hall modes.

Surround modes are selected using either the front panel controls or the remote. To select a new surround mode from the front panel, first press the **Surround Mode Group Selector Button** **5** until the desired major surround mode group such as Dolby, DTS or Logic 7 is selected. Next, press the **Surround Mode Selector Button** **9** to choose the specific individual surround mode.

To select a surround mode using the remote control, press the button for the major surround mode group that includes the mode you wish to choose from: **Dolby** **23**, **DTS Surround** **24**, **DTS Neo:6** **30**, **Logic 7** **25**, **Stereo** **29** or **DSP Surround** **11**. The first press of the button will show the current mode from that group if it is already in use, or the first available mode if you are currently using another mode. To cycle through the available modes in that group press the button again until the desired mode appears in the **Main Information Display** **23** and the on-screen display.

To select from the DSP modes (Hall 1, Hall 2, Theater) press the **Surround Mode Selector** **11** repeatedly to scroll through the list of available modes.

As the surround modes change, a blue LED will light next to the current mode in the **Surround Mode Indicators** **19** list on the front panel.

Note that the Dolby Digital or DTS modes may only be selected when a digital input is in use. In addition, when a digital source is present, the AVR will automatically select and switch to the correct mode (Dolby Digital or DTS), regardless of the mode that has been previously selected. For more information on selecting digital sources, see the following section of this manual.

When the 6-Channel direct inputs are in use there is no surround processing, as these inputs take the analog output signals from an optional,

external DVD-Audio or SACD player, or another source device and carry them straight through to the volume control.

To listen to a program in traditional two-channel stereo, using the front left and front right speakers only (plus the subwoofer, if installed and configured), press the **Stereo Button** **5** **29** until **SURR OFF** appears in the **Main Information Display** **23**.

### Digital Audio Playback

Digital audio is a major advancement over older analog surround processing systems such as Dolby Pro Logic. It delivers five discrete channels: left front, center, right front, left surround and right surround. Each channel reproduces full frequency range (20Hz to 20kHz) and offers dramatically improved dynamic range and significant improvements to signal-to-noise ratios. In addition, digital systems have the capability to deliver an additional channel that is specifically devoted to low-frequency information. This is the ".1" channel referred to when you see these systems described as "5.1". The bass channel is separate from the other channels, but since it is intentionally bandwidth-limited, sound designers have given it that unique designation.

#### Dolby Digital

Dolby Digital (originally known as AC-3<sup>®</sup>) is a standard part of DVD, and is available on specially encoded LD discs and satellite broadcasts and it is a part of the new high-definition television (HDTV) system.

Note that an optional, external RF demodulator is required to use the AVR to listen to the Dolby Digital sound tracks available on laser discs. Connect the RF output of the LD player to the demodulator and then connect the digital output of the demodulator to the **Optical** or **Coaxial** inputs **23/24/18/20** of the AVR.

No demodulator is required for use with DVD players or DTS-encoded laser discs.

#### DTS

DTS is another digital audio system that is capable of delivering 5.1 audio. Although both DTS and Dolby Digital are digital, they use different methods of encoding the signals, and thus they require different decoding circuits to convert the digital signals back to analog.

DTS-encoded sound tracks are available on select DVD and LD discs, as well as on special audio-only DTS CDs. You may use any LD, DVD or CD player equipped with a digital output to play DTS-encoded special audio-only CDs with the AVR, but DTS-LDs can be played on LD players and DTS-DVDs on DVD players only. All that is required is to connect the player's digital output to either the **Optical** or **Coaxial** input on the rear panel **23/24** or front panel **18/20**.



## Operation

In order to listen to DVDs encoded with DTS sound tracks, the DVD player must be compatible with the DTS signal as indicated by a DTS logo on the player's front panel. Note that early DVD players may not be able to play DTS-encoded DVDs. This does not indicate a problem with the AVR, as some players cannot pass the DTS signal through to the digital outputs. If you are in doubt as to the capability of your DVD player to handle DTS DVDs, consult the player's owner's manual.

Please note that some DVD players are shipped with their output set for Dolby Digital only. To insure that DTS data is being sent to the AVR, please check the setup menu system on your DVD player to make certain that DTS data output is enabled.

### PCM Audio Playback

PCM (Pulse Code Modulation) is the non-compressed digital audio system used for compact discs, Non-Dolby Digital/DTS Laserdiscs and some special PCM encoded DVDs. The digital circuits in the AVR are capable of high quality digital-to-analog decoding, and they may be connected directly to the digital audio output of your CD/DVD or LD player (LD only for PCM or DTS programs, for Dolby Digital laser discs an RF adapter is needed, see "Dolby Digital" above).

Connections may be made to either the **Optical** or **Coaxial** inputs **23/24** on the rear panel or the front panel **Digital Inputs 18/20**.

To listen to a PCM digital source, first select the input for the desired source (e.g., CD) to feed its video signal (if any) to the TV monitor and to provide its analog audio signal for recording. Next press the **Digital Select** button **25 17** and then use the **▲/▼** buttons **14** on the remote, or the **Selector** buttons **7** on the front panel, until the desired choice appears in the **Main Information Display 23**, then press the **Set** button **12 16** to confirm the choice.

During PCM playback the unit automatically will turn to the default surround mode or to the **LOGIC 7** mode but you also may select any surround mode except Dolby Digital or DTS.

### Selecting a Digital Source

To utilize either digital mode you must have properly connected a digital source to the AVR. Connect the digital outputs from DVD players, HDTV receivers, satellite systems or CD players to the **Optical** or **Coaxial** inputs on the rear or front panel **23/24/18/20**. In order to provide a backup signal and a source for analog stereo recording, the analog outputs provided on digital source equipment should also be connected to their appropriate inputs on the AVR rear panel (e.g., connect the analog stereo audio output from a DVD to the **DVD Audio inputs 6** on the rear panel when you connect the source's digital outputs).

To select a digital source such as DVD, first select its input using the remote or front panel **Input Selector 5 15** as outlined in this manual in order to feed its video signal (if any) to the TV monitor and to provide its analog audio signal for recording. When the digital input associated with the input selected (e.g. "DVD") is not selected automatically (due to the input settings made earlier during the system configuration, see page 18), select the digital source by pressing the **Digital Input Selector** button **17 25** and then using the **▲/▼** buttons **14** on the remote or the **Selector** buttons **7** on the front panel to choose any of the **OPTICAL** or **COAXIAL** inputs, as they appear in the **Main Information Display 23** or on-screen display.

When the digital source is playing, the AVR will automatically detect whether it is a multichannel Dolby Digital or DTS source or a conventional PCM signal, which is the standard output from CD players.

Note that a digital input (e.g. coaxial) remains associated with any analog input (e.g. DVD) as soon as it is selected, thus the digital input need not be re-selected each time the appropriate input choice (e.g. DVD) is made.

### Digital Bitstream Indicators

When a digital source is playing, the AVR senses the type of bitstream data that is present. Using this information, the correct surround mode will automatically be selected. For example, DTS bitstreams will cause the unit to switch to DTS decoding, and Dolby Digital bitstreams will enable Dolby Digital decoding. When the unit senses PCM data, from CDs and LDs and some music DVDs or certain tracks on normal DVDs, it will allow the appropriate surround mode to be selected manually. Since the range of available surround modes depends on the type of digital data that is present, the AVR uses a variety of indicators to let you know what type of signal is present. This will help you to understand the choice of modes and the input channels recorded on the disc.

When a digital source is playing, the AVR will display a variety of messages to indicate the type of bitstream received. These messages will appear shortly after an input or surround mode is changed, and will remain in the **Main Information Display 23** for about five seconds before the display returns to the normal surround mode indication.

## Surround Mode Types

For Dolby Digital and DTS sources, a three digit indication will appear, showing the number of channels present in the data. An example of this type of display is 3/2/.1.

The first number indicates how many discrete front channel signals are present.

- A 3 tells you that separate front left, center and front right signals are available. This will be displayed for Dolby Digital 5.1 and DTS 5.1 programs.
- A 2 tells you that separate front left and right signals are available, but there is no discrete center channel signal. This will be displayed for Dolby Digital bit streams that have stereo program material.
- A 1 tells you that there is only a mono channel available in the Dolby Digital bitstream.

The middle number indicates how many discrete surround channel signals are present.

- A 2 tells you that separate surround left and right signals are available. This will be displayed for Dolby Digital 5.1 and DTS 5.1 programs.
- A 1 tells you that there is only a single, surround encoded surround channel. This will appear for Dolby Digital bit streams that have matrix encoding.
- A 0 indicates that there is no surround channel information. This will be displayed for two-channel stereo programs.

The last number indicates if there is a discrete Low Frequency Effects (LFE) channel. This is the ".1" in the common abbreviation of "5.1" sound and it is a special channel that contains only bass frequencies.

- A .1 tells you that an LFE channel is present. This will be displayed for Dolby Digital 5.1 and DTS 5.1 programs, as available.
- A 0 indicates that there is no LFE channel information available. However, even when there is no dedicated LFE channel, low frequency sound will be present at the subwoofer output when the speaker configuration is set to show the presence of subwoofer.

An **UNLOCK** message may appear in the **Lower Display Line 23**. This is your indication that the digital audio data stream has been interrupted or is no longer present. When that occurs, the unit's digital signal processor has no signal to lock onto, and is thus "unlocked." You may see this message when a DVD is first started until the stream is playing and the processor determines which mode to apply; or any time the data stream is stopped or paused, such as when the menus of some discs are displayed or when the player is switching between the different sections of a disc. You may also see the message when a

# Operation

satellite receiver, cable set-top or HDTV tuner is in use if the digital audio is temporarily interrupted when channels are changed or when a cable box switches from a channel with a digital data stream to a channel with analog audio only. The **UNLOCK** message is normal, and does not indicate any problem with your receiver. Rather, it tells you that the incoming data has simply been paused or is not present for a variety of possible reasons.

When Dolby Digital 3/2/1 or DTS 3/2/1 signals are being played, the AVR will automatically switch to the proper surround mode, and no other processing may be selected. When a Dolby Digital signal with a 3/1/0 or 2/0/0 signal is detected you may select any of the Dolby surround modes.

### Surround Mode Post Processing

Thanks to the power of the AVR 147's DSP processor, a variety of surround mode options are available for most digital signals to deliver either the native information or to produce an enhanced sound field to match the number of speakers in your system. The modes available and the number of channels available for each mode will vary depending on the incoming bitstream, and the configuration of your system, and are listed in the tables below. The modes may be selected in the usual manner by selecting the major Surround Mode Group first, and then scrolling through the options.

The incoming bitstreams are indicated in the **Lower Display Line 23** as described above. After you have selected a surround mode, after about 5 seconds, the bitstream will be displayed briefly before the unit returns to normal operation. Therefore, you may ascertain the current bitstream simply by pressing the button for the major Surround Mode Group and waiting for a few moments for the bitstream to appear in the **Lower Display Line 23**. The bitstream information will also be displayed after the source input has been changed.

For incoming Dolby Digital signals, the following modes are available:

Incoming Bitstream	Available Surround Modes
Dolby Digital 1/0/0 or 1/0/1	Dolby Digital, Dolby Digital Stereo, Dolby Virtual Speaker Reference (2 Speaker), Dolby Virtual Speaker Wide (2 Speaker)
Dolby Digital 2/0/0 or 2/0/1	Dolby Pro Logic II (Movie, Music or Game), Dolby Pro Logic, Dolby Digital, Dolby Virtual Speaker Reference (2 or 3 Speaker), Dolby Virtual Speaker Wide (2, 3, 4 or 5 Speaker)
Dolby Digital 3/0/0 or 3/0/1	Dolby Digital, Dolby Digital Stereo, Dolby Virtual Speaker Reference (2 or 3 Speaker), Dolby Virtual Speaker Wide (2 or 3 Speaker)
Dolby Digital 2/1/0 or 2/1/1	Dolby Digital, Dolby Digital Stereo, Dolby Virtual Speaker Reference (2 or 3 Speaker), Dolby Virtual Speaker Wide (2, 3, 4 or 5 Speaker)
Dolby Digital 2/2/0 or 2/2/1	Dolby Digital, Dolby Digital Stereo, Dolby Virtual Speaker Reference (2 Speaker), Dolby Virtual Speaker Wide (2 or 4 Speaker)
Dolby Digital 3/2/0, 3/2/1	Dolby Digital, Dolby Digital Stereo, Dolby Virtual Speaker Reference (2 or 3 Speaker), Dolby Virtual Speaker Wide (2, 3, 4 or 5 Speaker)

To use the table below, match the indication in the display to the Incoming Bitstream listed in the left column. The available surround modes are shown to the right.

It is always a good idea to check the readout for the channel data to make certain that it matches the audio logo information shown on the back of a DVD package. In some cases you will see indication for "2/0/0" even when the disc contains a full 5.1, or 3/2/1 signal. When this happens, check the audio output settings for your DVD player or the audio menu selections for the specific disc being played to make certain that the player is sending the correct signal to the AVR.

### PCM Playback Indications

PCM is the abbreviation for Pulse Code Modulation, which is the type of digital signal used for standard CD playback, and other non-Dolby Digital and non-DTS digital sources such as Mini-Disc. When a PCM signal is detected, the **Main Information Display 23** will briefly show a message with the letters PCM, in addition to a readout of the sampling frequency of the digital signal.

Connections may be made to either the rear-panel **Optical** or **Coaxial Inputs 23/24** or the front-panel **Digital Inputs 18/20**.

To listen to a PCM digital source, first select the input for the desired source (e.g., CD). Next press the **Digital Select Button 25/17** and then use the **▲/▼ Buttons 14** on the remote, or the **◀/▶ Selector Buttons 7** on the front panel, until the desired choice appears in the **Upper Display Line 23**.

During PCM playback, you may select any Surround mode except Dolby Digital or DTS, as shown in the table below. Note that for convenience, we have included the modes available for analog sources (including the tuner) in the chart on the bottom of this page.

In most cases this will be **48 KHZ**, though in the case of specially mastered, high-resolution audio discs you will see a **96 KHZ** indication.

The **PCM 48 KHZ** indication will also appear when modes or inputs are changed for analog sources. In those cases the system is telling you the sampling frequency used internally at the output of the analog-to-digital converters that change the incoming signal from a VCR, tape deck, the tuner, or other analog source to digital.

### Speaker/Channel Indicators

In addition to the **Bitstream Indicators**, the AVR features a set of unique channel-input indicators that tell you how many channels of digital information are being received and/or whether the digital signal is interrupted. (See Figure).

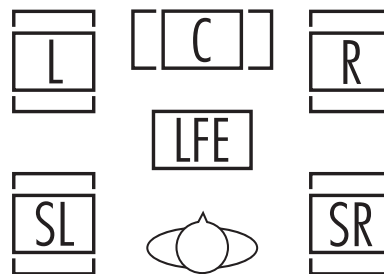

These indicators are the L/C/R/LFE/SL/SR letters that are inside the center boxes of the **Speaker/Channel Input Indicators 14** in the front panel **Main Information Display 23**.

When a standard analog stereo or matrix surround signal is in use, only the "L" and "R" indicators will light, as analog signals have only left and right channels.

Digital signals, however, may have one, two, five separate channels, depending on the program material, the method of transmission and the way in which it was encoded. When a digital signal is playing, the letters in these indicators will light in response to the specific signal being received. It

## Operation

For incoming DTS signals, the following modes are available:

Incoming Bitstream	Available Surround Modes
DTS 1/0/.0, 1/0/.1, 2/0/.0, 2/0/.1, 3/0/.0, 3/0/.1, 3/1/.0 or 3/1/.1	DTS, DTS Stereo
DTS 2/2/.0, 2/2/.1, 3/2/.0 or 3/2/.1	DTS, DTS Stereo
DTS 96/24	DTS 96/24, DTS Stereo
DTS-ES Matrix	DTS, DTS Stereo
DTS-ES Discrete	DTS, DTS Stereo

is important to note that although Dolby Digital, for example, is referred to as a "5.1" system, not all Dolby Digital DVDs or audio tracks selected on DVD or other Dolby Digital programs are encoded for 5.1. Thus, it is sometimes normal for a DVD with a Dolby Digital soundtrack to trigger only the "L" and "R" indicators.

**NOTE:** Many DVD discs are recorded with both "5.1" and "2.0" versions of the same soundtrack. When playing a DVD, always be certain to check the type of material on the disc. Most discs show this information in the form of a listing or icon on the back of the disc jacket. When a disc does offer multiple soundtrack choices, you may have to make some adjustments to your DVD player (usually with the "Audio Select" button or in a menu screen on the disc) to send a full 5.1 feed to the AVR or to select the appropriate audio track and thus language. It is also possible for the type of signal feed to change during the course of a DVD playback. In some cases the previews of special material will only be recorded in 2.0 audio, while the main feature is available in 5.1 audio. As long as your DVD player is set for 6-channel output, the AVR will automatically sense changes to the bitstream and channel count and reflect them in these indicators.

The letters used by the **Speaker/Channel Input Indicators 14** also flash to indicate when a bitstream has been interrupted. This will happen when a digital input source is selected before the playback starts, or when a digital source such as a DVD is put into a Pause mode. The flashing indicators remind you that the playback has stopped due to the absence of a digital signal and not through any fault of the AVR. This is normal, and the digital playback will resume once the playback is started again.

### Incoming Signal

Analog (2-channel), Tuner, PCM 44.1kHz or 48kHz

PCM 96kHz

### Night Mode

A special feature of Dolby Digital is the Night mode, which enables Dolby Digital input sources to be played back with full digital intelligibility while reducing the maximum peak level and lifting the low levels by 1/4 to 1/3. This prevents abruptly loud transitions from disturbing others without reducing the impact of the digital source. The Night mode is available only when the Dolby Digital mode is selected.

The Night mode may be engaged when a Dolby Digital DVD is playing by pressing the **Night Button 12** on the remote. Next, press the **▲/▼** buttons **14** to select either the middle range or full compression versions of the Night mode. To turn the Night mode off, press the **▲/▼** buttons **14** until the message in the lower third of the video display and the **Main Information Display 23** reads **D - RANGE OFF**.

The Night mode may also be selected to always be on as soon as the Dolby Digital mode is activated at either level of compression using the options in the **DOLBY** menu. See page 20 for information on using the menus to set this option.

### IMPORTANT NOTES ON DIGITAL PLAYBACK:

- When the digital playback source is stopped, or in a pause, fast forward or chapter search mode, the digital audio data will momentarily stop, and the channel position letters inside the **Speaker/Channel Indicators 14** will flash. This is normal and does not indicate a problem with either the AVR or the source machine. The AVR will return to digital playback as soon as the data is available and when the machine is in a standard play mode.

- Although the AVR will decode virtually all DVD movies, CDs and HDTV sources, it is possible that some future digital sources may not be compatible with the AVR.

- Note that not all digitally encoded programs and not all audio tracks on a DVD contain full 5.1 channel audio. Consult the program guide that accompanies the DVD or laser disc to determine which type of audio has been recorded on the disc. The AVR will automatically sense the type of digital surround encoding used, indicate it in the **Channel Input Indicators 14** and adjust to accommodate it.

- When a Dolby Digital or DTS source is playing, you normally may not be able to select some of the analog surround modes such as Dolby Pro Logic II, Dolby 3 Stereo, Hall, Theater, 5CH Stereo or Logic 7, except with specific Dolby Digital 2.0 recordings that can be played with the Pro Logic II modes too (see page 30).

- When a digital source is playing, it is NOT possible to make an analog recording using the **Tape 4** or **Video 1 8** record outputs, even if the source is connected to any digital input of the AVR only, as long as "Surround Off" mode is selected (possible with a PCM source only). But the analog two channel signal, even of a Dolby Digital (not DTS) source, the "Downmix" to Stereo or Dolby Surround, can be recorded by connecting its analog audio outputs to the appropriate analog inputs (e.g. DVD) of the AVR. Additionally, the digital signals will be passed through to the **Digital Audio Outputs 11**.

### Available Surround Modes

Dolby Pro Logic II (Movie, Music or Game), Dolby Pro Logic, Dolby 3 Stereo, Dolby Virtual Speaker Reference (2 or 3 Speaker), Dolby Virtual Speaker Wide (2, 3, 4 or 5 Speaker), DTS Neo:6 (3-channel Cinema, 5-channel Cinema or Music), Logic 7 (5-channel Cinema, Music or Enhance), Hall 1 (5-channel), Hall 2 (5-channel), Theater (5-channel), Surround Off\*\*, 5-Channel Stereo, DSP Surround Off

Dolby Pro Logic II (Movie or Music), Dolby Pro Logic, Logic 7 (5-channel Cinema, Music or Enhance), DSP Surround Off

\*\* The Surround Off mode is only available for analog sources or the tuner, and requires that the tone controls be removed from the circuitry for "flat" response. Otherwise, the DSP Surround Off mode may be selected when a two-channel presentation is desired.

# Operation

## Tape Recording

In normal operation, the audio or video source selected for listening through the AVR is sent to the record outputs. This means that any program you are watching or listening to may be recorded simply by placing machines connected to the outputs for **Tape Outputs 4** or **Video 1 Outputs 26 8** in the record mode.

When a digital audio recorder is connected to any of the **Digital Audio Outputs 11**, you are able to record the digital signal using a CD-R, MiniDisc or other digital recording system.

Note that all digital signals will be passed through to both, coaxial and optical, digital outputs simultaneously, no matter which kind of digital input was selected.

### NOTES:

- The digital outputs are active only when a digital signal is present, and they do not convert an analog input to a digital signal, or change the format of the digital signal (e.g. Dolby Digital to PCM or vice versa, but coaxial digital signals are converted to optical signals and vice versa). In addition, the digital recorder must be compatible with the output signal. For example, the PCM digital output from a CD player may be recorded on a CD-R or MiniDisc, but Dolby Digital or DTS signals may not.

- To make an analog recording from a digital source is possible, but only from a PCM source (not Dolby Digital or DTS) and correctly only with "Surround Off" mode (with any Surround mode only the L/R front signals will be fed to the record outputs).

## Using The Bridge

When Harman Kardon's **The Bridge** (optional) is connected and a compatible Apple® iPod® is docked in The Bridge, press the **The Bridge DMP Selector Button 41** to choose the iPod as the input source allowing playback of audio, video and still-image materials on your iPod through your high-quality audio/video system. Pressing the **The Bridge DMP Selector Button 41** will also activate the AVR remote's control codes for the iPod, and you may also use the front-panel controls to operate the iPod. You may also select **The Bridge DMP** as the source from the front panel by repeatedly pressing the **Input Source Selector 15** until **DMP** appears in the **Upper Display Line 23**, although no **Input Indicator 22** will light.

When The Bridge is properly connected and a compatible iPod is properly docked, the **Upper Display Line 23** will read **DMP / CONNECTED**.

Once that message appears, use the remote or front-panel buttons to control the iPod. See the Function List Table further down on this page for a listing of the remote control buttons that have

been programmed to control the iPod. In brief, the **Reverse Search, Play and Forward Search Buttons 26** and the **▲/▼/◀▶ Buttons 14 15 37** and **Set Button 16** may be used in a similar manner to the corresponding controls on the iPod. Complete details on operating an iPod using **The Bridge**, and an AVR remote are furnished with **The Bridge**.

### NOTES:

- The Play and Pause functions are not available unless content has been selected for playback by navigating the menu system.
- For the Search function, press and hold the indicated button. Pressing the Previous Track Button once skips to the beginning of the current track. Press the Previous Track Button twice to skip to the beginning of the previous track.

The front-panel controls may be used to access a limited number of iPod functions. Press the **RDS select button 16** to play or pause the current track. The **Tuning Selector 10** may be used to search reverse (left side of button) or forward (right side of button) through the tracks. Press the **Tuner Band Selector 11** to call up the iPod's menu. Press the **Preset Stations Selector 13** to scroll, and the **Set Button 12** to select.

While a selection is playing, the song title, artist and album name, if available on the iPod, will scroll across the upper line in the front panel **Message Display 23**. The lower line will display the elapsed time of the track on the left, the play mode icon, and the time remaining on the right.

In addition, if a video display is connected to the AVR, a screen will appear briefly to display information about the iPod's status and the track. The top line will display the play mode icon, with the phrase "Now Playing" appearing to the right to remind you that you are viewing the status of the current track, as opposed to another menu screen. Below that the AVR displays the total number of tracks in the current play list on the right (all materials on the iPod are considered one of the play lists) with the number of the current track on the left.

iPod Function	Remote Control Key	Front-Panel Button
Play	Play (▶)	RDS
Pause	Pause (II)	RDS
Menu	Menu (Spkr)	Tuner Band (AM/FM)
Select	Set	Set
Scroll Forward	Left Arrow (◀)	Preset Down
Scroll Reverse	Right Arrow (▶)	Preset Up
Forward Search/Next Track	Forward/Next (▶▶)	Tuning Up
Reverse Search/Previous Track	Reverse/Previous (◀◀)	Tuning Down

The song title, artist and album are displayed. At the bottom of the screen is a graphic bar indicating the current play position within the track, with the elapsed and remaining times appearing below the bar.

After a period of time the screen may disappear from view. The length of time is set using the Full-OSD Time Out setting in the System Settings menu (described in the Advanced Functions section). You may restore the Now Playing screen to view by pressing either of the **◀▶ Buttons 15 37**, and you may then navigate the menus as explained above.

**NOTE:** It is strongly recommended that you use a screen saver built into your video display to avoid possible damage from "burn-in" that may occur with plasma and many CRT displays when a still image, such as a menu screen, remains on display for an extended period of time.

### NOTES ON VIDEO PLAYBACK:

- Before attempting to play videos stored on your iPod, check the Video Settings menu on the iPod and make sure that the TV Out setting is set to On. The TV Signal setting should be PAL to match the capabilities of your video display. Set Widescreen to On or Off, depending on the aspect ratio of your video display. If your selection was playing and paused at the time you changed the TV Out setting, the iPod may require you to navigate its menu system and reselect the video for the new TV Out setting to take effect. Resuming play from the Now Playing function may not reflect the change to the TV Out setting. This is a function of the iPod, not the AVR 147.
- In Video mode, the iPod's menus will not be visible on your video display, although you may view them on the iPod's screen. You may operate the iPod using the AVR remote, as long as it is in The Bridge device mode.
- You may view the AVR's on-screen displays while The Bridge is in use, just as you would with any other video source.



## Operation

### Output Level Adjustment With Source Signals

Normal output level adjustment for the AVR is established using the test tone, as outlined on page 27-28. In some cases, however, it may be desirable to adjust the output levels using program material such as a test disc, or a selection you are familiar with. Additionally, the output level for the subwoofer and those for the Stereo modes can only be adjusted using this procedure.

To adjust the output levels using program material, first select the surround mode for which you want to trim the speakers (see NOTE below), start your program material source and set the reference volume for the front left and front right channels using the **Volume Control** 40.

Once the reference level has been set, press the **Channel Select** button 13 26 and note that **FRONT LEVEL** will appear in the **Main Information Display** 23. To change the level, first press the **Set** button 16 12, and then use the **Selector** buttons 7 or the **▲/▼** buttons 14 to raise or lower the level. DO NOT use the volume control, as this will alter the reference setting.

Once the change has been made, press the **Set** button 16 12 and then press the **Selector** buttons 7 or the **▲/▼** buttons 14 to select the next output channel location that you wish to adjust. To adjust the subwoofer level, press the **Selector** buttons 7 or the **▲/▼** buttons 14 until **W O O F E R LEVEL** appears in the **Main Information Display** 23 or on-screen display (only available if the subwoofer is turned on).

Press the **Set** button 16 12 when the name of the desired channel appears in the **Main Information Display** 23 and on-screen display, and follow the instructions shown above to adjust the level.

Repeat the procedure as needed until all channels requiring adjustment have been set. When all adjustments have been made and no further adjustments are made for five seconds, the AVR will return to normal operation.

The channel output may also be adjusted using the full-OSD on-screen menu system. First, set the volume to a comfortable listening level using the **Volume Control** 27 40. Then, press the **OSD** button 22 to bring up the **MASTER MENU** (Figure 1). Press the **▼** Button 14 three times until the on-screen **▶** cursor is next to the **MANUAL ADJUST** line. Press the **Set** Button 16 to activate the **MANUAL ADJUST** and use the **▲/▼** 14 to scroll to the **CHANNEL ADJUST** line. Press the **Set** Button 16 to display the **CHANNEL ADJUST** submenu.



Figure 12

When the menu appears, the internal test tone will be turned off. This will allow you to use your external test disc or other source material as the test signal. Then, use the **▲/▼** Buttons 14 to select the channels to be adjusted. At each channel position use the **◀/▶** Buttons 15 37 to change the output level.

Remember, when you are using a disc with test signal (e.g. pink noise) or an external signal generator as the source, the goal is to have the output level at each channel be equal when heard at the listening position, with any surround mode selected. When your test source is a normal disc with music signals, you may adjust the level for each channel and surround mode as you prefer, e.g. you may lower the center channel level when you find it to be too high or increase the level of the rears when you find it to be too low with specific surround modes.

If you wish to reset all the levels to their original factory default of 0dB offset, press the **▲/▼** Buttons 14 so that the on-screen cursor is next to the **CHANNEL RESET** line and press the **◀/▶** Buttons 15 37 so that the word **ON** is highlighted. After the levels are reset, resume the procedure outlined above to reset the levels to the desired settings. When all adjustments are done, press the **▲/▼** Buttons 14 to move the on-screen **→** cursor so that it is next to **BACK TO MASTER MENU** and then press the **Set** Button 16 if you wish to go back to the main menu to make other adjustments. If you have no other adjustments to make, press the **OSD** Button 22 to exit the menu system.

**NOTE:** The output levels may be separately trimmed for each digital and analog surround mode. If you wish to have different trim levels for a specific mode, select that mode and then follow the instructions in the steps shown above.

With Stereo modes the adjustment procedure described above is the only way to trim the output level, e.g. to match the Stereo level with other modes.

### Dim Function

Since the AVR will often be used when movies or other video programming is viewed under low-light conditions, you may wish to lower the brightness of the front-panel displays and indicators so that they do not distract from the video presentation. You may dim the displays using the menu system, as shown on this page, or you may control the brightness directly from the remote.

Simply press the **Dim Button** 43 once to dim the front panel to half the normal brightness level; press it again to turn the displays off. Note that when the displays are dimmed or turned off, the blue lighting around the **Standby/On** Switch 2 will continue to stay lit as a reminder that the AVR is still turned on.

Note that all changes to the front-panel brightness level are temporary; the displays will return to full brightness after the AVR is turned off and then on again. To return the displays to full brightness without turning the unit off, press the **Dim Button** 43 as needed until the displays are on.

In addition to lowering the brightness of the displays or turning them off completely, you may wish to have them appear whenever a button on the remote or front panel is pushed, and then gradually fade out after a set time period. You may do this by making the appropriate settings in the **VFD FADE TIME OUT** line of the **SYSTEM SETUP** menu, as shown on page 39.

### Memory Backup

This product is equipped with a memory backup system that preserves tuner presets and system configuration information if the unit is turned off completely, accidentally unplugged or subjected to a power outage. This memory will last for approximately two weeks, after which time all information must be reentered.

## System Setup

The AVR 147 is equipped with a number of advanced features that add extra flexibility to the unit's operation. While it is not necessary to use these features to operate the unit, they provide additional options that you may wish to use.

### Front-Panel-Display Fade

In normal operation, the front-panel displays and indicators remain on at full brightness, although you may also dim them or turn them off as shown on page 38. As an additional option, you may also set the AVR so that the displays are on whenever a button is pressed on the front panel or remote, but then fade out after a set period of time.

To set the front-panel displays to the Fade mode, press the **OSD Button 22** to bring the Master Menu to the screen. Press the **▲/▼ Navigation Button 14** so that the **→** cursor is pointed to the **SYSTEM SETUP** line, and press the **Set Button 16** to enter the **SYSTEM SETUP** menu (Figure 13).



Figure 13

With the **SYSTEM SETUP** menu on your video display, press the **▲/▼ Navigation Button 14** so that the **→** cursor is pointed to the **UFD FADE TIME OUT** line. Next, press the **◀/▶ Navigation Button 15 37** so that the amount of time that you wish the displays to fade out after a button is pressed is shown.

Once this time is set and the unit returned to normal operation, the displays will remain on for the time period selected whenever a button is pressed on the front panel or remote. After that time they will gradually fade out, with the exception of the lighting surrounding the **Standby/On Switch 3**, which remains on to remind you that the AVR is turned on. Note that if the displays have been turned completely off using the Dim Button, as shown on page 38, the Fade function will not operate.

If you wish to make adjustments to other items on the **SYSTEM SETUP** menu, press the **▲/▼ Navigation Button 14** to place the **→** cursor next to the desired item, or place the **→** cursor next to the **BACK TO MASTER MENU** line and press the **Set Button 16** to make an adjustment to another menu. If you have completed all adjustments, press the **OSD Button 22** to exit the menu system.

### Turn On Volume Level

As is the case with most audio/video receivers, when the AVR is turned on, it will always return to the volume setting in effect when the unit was turned off. However, you may prefer to always have the AVR turn on at a specific setting, regardless of what was last in use when the unit was turned off. To change the default condition so that the same volume level is always used at turn-on, you will need to make an adjustment in the **SYSTEM SETUP** menu. To start the adjustment, press the **OSD button 22** to bring the **MASTER MENU** (Figure 1) to the screen. Press the **▲** button **14**, until the on-screen **→** cursor is next to the **SYSTEM SETUP** line. Press the **Set** button **16** to enter the **SYSTEM SETUP** menu (Figure 13).

At the **SYSTEM SETUP** menu make certain that the on-screen **→** cursor is next to the **VOLUME DEFAULT** line by pressing the **▲/▼** buttons **14** as needed. Next, press the **▶** button **37** so that the word **ON** is shown in the video display. Next, press the **▼** button **14** once so that the on-screen **▶** cursor is next to the **DEFAULT VOL SET** line. To set the desired turn-on volume, press the **◀/▶** buttons **15 37** or hold them pressed until the desired volume level is shown on the **DEFAULT VOL SET** line. Note that this setting may NOT be made with the regular volume controls.

**NOTE:** Since the setting for the turn-on volume cannot be heard while the setting is being made, you may wish to determine the setting before making the adjustment. To do this, listen to any source and adjust the volume to the desired level using the regular volume controls **40**. When the desired volume level to be used at turn-on is reached, make a note of the setting as it appears in the lower third of the video screen or in the **Main Information Display 23**.

A typical volume level will appear as a negative number such as -25dB. When making the adjustment, use the **◀/▶** buttons **15 37** to enter this setting.

Unlike some of the other adjustments in this menu, the turn-on volume default will remain in effect even when the unit is turned off completely, unless it is changed or turned off in this menu.

If you wish to make other adjustments in the menu, press the **▲/▼** Buttons **14** until the on-screen **→** cursor is next to the desired setting or the **BACK TO MASTER MENU** line and press the **Set** button **16**. If you have no other adjustments to make, press the **OSD Button 22** to exit the menu system.

### Semi-OSD Settings

The semi-OSD system places one line messages at the lower third of the video display screen whenever the Volume, Input Source, Surround mode or tuner frequency of any of the configuration settings are changed. The semi-OSD system is helpful in that enables you to have feedback on any control changes or remote commands using the video display when it is difficult to view the front-panel displays. However, you may occasionally prefer to turn these displays off for a particular listening session. You may also want to adjust the length of time the displays remain on the screen. Both of those options are possible with the AVR.

To turn off the semi-OSD system, you will need to make an adjustment in the **SYSTEM SETUP** menu (Figure 13). To start the adjustment, press the **OSD button 22** to bring the **MASTER MENU** to the screen. Press the **▲** Button **14**, until the on-screen **→** cursor is next to the **SYSTEM SETUP** line. Press the **Set** Button **16** to enter the **SYSTEM SETUP** menu.

At the **SYSTEM SETUP** menu make certain that the on-screen **→** cursor is next to the **SEMI OSD** line by pressing the **▲/▼** buttons **14** as needed. Next, press the **▶** button **37** so that the word **OFF** is shown in the video display.

Note that this setting is temporary and will remain active only until it is changed or until the AVR is turned off. Once the unit is turned off, the semi-OSD displays will remain activated, even if they were switched off for the previous listening session.

To change the length of time that the semi-OSD displays remain on the screen, go to the **SYSTEM SETUP** Menu as outlined earlier, and press the **▲/▼** buttons **14** as needed, until the on-screen **→** cursor is next to the **SEMI - OSD TIME OUT** line. Next, press the **◀/▶** Buttons **15 37** until the desired time in seconds is displayed. Note that unlike most of the other options in this menu, this is a permanent setting change, and the time-out entry will remain in effect until it is changed, even when the unit is turned off.

If you wish to make other adjustments in the menu, press the **▲/▼** Buttons **14** until the on-screen **→** cursor is next to the desired setting or the **BACK TO MASTER MENU** line and press the **Set** button **16**. If you have no other adjustments to make, press the **OSD Button 22** to exit the menu system.

## System Setup

### Full-OSD Time Out Adjustment

The **FULL OSD** menu system is used to simplify the setup and adjustment of the AVR using a series of on-screen menus. The factory default setting for these menus leaves them on the screen for 20 seconds after a period of inactivity before they disappear from the screen or Time Out. This Time Out is a safety measure to prevent the menu text from burning into the CRTs in your monitor or projector, which might happen if they were left on indefinitely. However, some viewers may prefer a slightly longer or shorter period before the Time Out display.

To change the Full-OSD Time Out, you will need to make an adjustment in the **SYSTEM SETUP** menu (Figure 13). To start the adjustment, press the **OSD** button **22** to bring the **MASTER MENU** to the screen. Press the **▲** button **14**, until the on-screen **→** cursor is next to the **SYSTEM SETUP** line. Press the **Set** Button **16** to enter the **SYSTEM SETUP** menu (Figure 13).

At the **SYSTEM SETUP** menu make certain that the on-screen **→** cursor is next to the **FULL OSD TIME OUT** line by pressing the **▲/▼** Buttons **14** as needed. Next, press the **◀/▶** buttons **15/37** until the desired time is displayed in seconds. Note that unlike most of the other options in this menu, this is a permanent setting change, and the time-out entry will remain in effect until it is changed, even when the unit is turned off.

If you wish to make other adjustments in the menu, press the **▲/▼** Buttons **14** until the on-screen **→** cursor is next to the desired setting or the **BACK TO MASTER MENU** line and press the **Set** button **16**. If you have no other adjustments to make, press the **OSD** Button **22** to exit the menu system.

### Default Surround Mode

In normal operation, when the AVR senses a Dolby Digital or DTS digital audio data stream, it will automatically switch the appropriate default surround mode, with the AVR responding to the data flags that are encoded on the DVD disc or in the digital video broadcast. In most cases, this is the correct mode, but you may have a particular preference for the mode you wish to hear when Dolby Digital or DTS is present. The AVR allows you to set the unit so that it will either respond to the default or switch to your desired mode.

If you wish to leave the default so that the mode choice encoded in the disc is always used, no further action is needed. Simply leave the setting at the factory default of ON.

To set the unit so that it responds to the last surround mode used when a Dolby Digital or DTS source is playing, press the **▲/▼** Buttons **14** so that the **→** cursor is pointing to the **DEFAULT SURR MODE** line. Press the **◀/▶** Buttons **15/37** so that **OFF** appears, and the setting will change. The unit will now use the last mode, not the disc's default for the two digitally encoded data streams.

This setting does not apply to standard PCM digital inputs or to analog sources. In those cases, the unit will always apply the surround or processing mode that was last used for that input.

If you wish to make other adjustments, press the **▲/▼** Buttons **14** until the on-screen **→** cursor is next to the desired setting or the **RETURN TO MASTER MENU** line and press the **Set** Button **16**. If you have no other adjustments to make, press the **OSD** Button **22** to exit the menu system.

### Full-OSD Background Color

When the full-OSD menu system is in use, the default display appears with a solid blue background with white characters. If you wish, you may select a solid black background as the default. This setting may be changed by pressing the **OSD** Button **22** to display the **MASTER MENU**. Use the **▲/▼** Buttons **14** to scroll down to the **SYSTEM SETUP** line, and press the **Set** Button **16** to select the **SYSTEM SETUP** submenu. Press the **▲/▼** Buttons **14** again to scroll to the **OSD BACKGROUND** line. When **BLUE** appears, the full-OSD menus will appear on screen with a solid blue background. Press the **◀/▶** Buttons **15/37** until **BLACK** appears to display the full-OSD menus on a solid black background instead.

This setting will be retained even when the AVR 147 is turned off to the Standby mode.

If you wish to make other adjustments, press the **▲/▼** Buttons **14** until the on-screen **→** cursor is next to the desired setting or the **BACK TO MASTER MENU** line and press the **Set** Button **16**. If you have no other adjustments to make, press the **OSD** Button **22** to exit the menu system.

## Tuner Operation

### Basic Tuner Operation

The AVR 147's tuner is capable of tuning AM, FM and FM Stereo broadcast stations and receiving RDS data. Stations may be tuned manually, or they may be stored as favorite station presets and recalled from a 30 position memory.

#### Station Selection

1. Press the **AM/FM Tuner Select** button **7** on the remote to select the tuner as an input. The tuner may be selected from the front panel by either pressing the **Input Source Selector** **15** until the tuner is active or by pressing the **Tuner Band Selector** **11** at any time.

2. Press the **AM/FM Tuner Select** button **7** or **Tuner Band Selector** **11** again to switch between AM and FM so that the desired frequency band is selected.

3. Press the **Tuner Mode** button **19** on the remote or hold the **Band Selector** **11** on the front panel pressed for 3 seconds to select manual or automatic tuning.

When the button is pressed so that **AUTO** appears in the **Main Information Display** **23** each press of the **Tuning Selectors** **10** **21** will put the tuner in a scan mode that seeks the next higher or lower frequency station with acceptable signal strength. An **AUTO ST TUNED** indication will momentarily appear when the station stops at a stereo FM station, and an **AUTO TUNED** indication will momentarily appear when an AM or monaural FM station is tuned. Press the Tuning buttons again to scan to the next receivable station.

When the button is pressed so that **MANUAL** appears in the **Main Information Display** **23** each tap of the Selector will increase or decrease the frequency by one increment. When the tuner receives a strong enough signal for adequate reception, **MANUAL TUNED** will appear in the **Main Information Display** **23**.

4. Stations may also be tuned directly by pressing the **Direct** button **20**, and then pressing the **Numeric Keys** **18** that correspond to the station's frequency. Note that for entering numbers higher than 100 you need to enter only the "1" rather than "10", the first "0" will be added automatically. The desired station will automatically be tuned after the latest number is entered. If you press an incorrect button while entering a direct frequency, press the **Clear** button **34** to start over.

**NOTE:** When the FM reception of a stereo station is weak, audio quality will be increased by switching to Mono mode by pressing the **Tuner Mode** button **19** on the remote or holding the **Band Selector** **11** on the front panel so that **MANUAL** appears momentarily in the **Main Information Display** **23** and then goes out.

#### Preset Tuning

Using the remote, up to 30 stations may be stored in the AVR's memory for easy recall using the front panel controls or the remote.

To enter a station into the memory, first tune the station using the steps outlined above. Then:

1. Press the **Memory** button **35** on the remote. Note that two underscore lines will appear in the **Main Information Display** **23**.

2. Within five seconds, press the **Numeric Keys** **18** corresponding to the location where you wish to store this station's frequency. Once entered, the preset number will appear in the **Main Information Display** **23**.

3. Repeat the process after tuning any additional stations to be preset.

#### Recalling Preset Stations

- To manually select a station previously entered in the preset memory, press the **Numeric Keys** **18** that correspond to the desired station's memory location.

- To manually tune through the list of stored preset stations one by one, press the **Preset Stations Selector** buttons **13** **33** on the front panel or remote.



# Tuner Operation

## RDS Operation

The AVR 147 is equipped with RDS (Radio Data System), which brings a wide range of information to FM radio. Now in use in many countries, RDS is a system for transmitting station call signs or network information, a description of station program type, text messages about the station or specifics of a musical selection, and the correct time.

As more FM stations become equipped with RDS capabilities, the AVR will serve as an easy-to-use center for both information and entertainment. This section will help you take maximum advantage of the RDS system.

### RDS Tuning

When an FM station is tuned in and it contains RDS data, the AVR will automatically display the station's call sign or other program service in the **Main Information Display 23**.

### RDS Display Options

The RDS system is capable of transmitting a wide variety of information in addition to the initial station call sign that appears when a station is first tuned. In normal RDS operation the display will indicate the station name, broadcast network or call letters. Pressing the **RDS** button **16 42** enables you to cycle through the various data types in the following sequence:

- The station's call letters (with some private stations other information too).
- The station's frequency (**FRE Q**).
- The Program Type (**PTY**) as shown in the list below.

**NOTE:** Many stations do not transmit a specific PTY. The display will show **NONE**, when such a station is selected and PTY is active.

- A "text" message (Radiotext, **RT**) containing special information from the broadcast station. Note that this message may scroll across the display to permit messages longer than the eight positions in the display. Depending on signal quality, it may take up to 30 seconds for the text message to appear; in that time, the word **TEXT** will flash in the Information Display when RT is selected.
- The current time of day (**CT**). Note that it may take up to two minutes for the time to appear, in that time the word **TIME** will flash in the information display when CT is selected. Please note that the accuracy of the time data is dependent on the radio station, not the AVR.

Some RDS stations may not include some of these additional features. If the data required for the selected mode is not being transmitted, the **Main Information Display 23** will show a **NONE**, **NONE TEXT** or **NONE TIME** message after the individual time out.

In any FM mode the RDS function requires a strong enough signal for proper operation.

### Program Search (PTY)

An important feature of RDS is its capability of encoding broadcasts with Program Type (PTY) codes that indicate the type of material being broadcast. The following list shows the abbreviations used to indicate each PTY, along with an explanation of the PTY:

- **RDS ONLY**
- **TRAFFIC**
- **NEWS**: News
- **AFFAIRS**: Current Affairs
- **INFO**: Information
- **SPORT**: Sports
- **EDUCATE**: Educational
- **DRAMA**: Drama
- **CULTURE**: Culture
- **SCIENCE**: Sciencek
- **VARIED**: Varied Speech Programs
- **POPM**: Popular Music
- **ROCKM**: Rock Music
- **M · O · R · M · :** Middle-of-the-Road Music
- **LIGHTM**: Classical Music
- **CLASSICS**: Serious Classical Music
- **OTHERM**: Other Music
- **WEATHER**: Weather Information
- **FINANCE**: Financial Programs
- **CHILDREN**: Children's Programs
- **SOCIAL A**: Social Affairs Programs
- **RELIGION**: Religious Broadcasts
- **PHONE IN**: Phone-In Programs
- **TRAVEL**: Travel and Touring
- **LEISURE**: Leisure and Hobby
- **JAZZ**: Jazz Music

- **COUNTRY**: Country Music
- **NATIONAL**: National Music
- **OLDIES**: Oldies Music
- **FOLK M**: Folk Music
- **DOCUMENT**: Documentary Programs
- **TEST**: Emergency Test
- **ALARM**: Emergency Broadcast Information

You may search for a specific Program Type (PTY) by following these steps:

1. Press the **RDS** button **16 42** until the current PTY is shown in the **Main Information Display 23**.
2. While the PTY is shown, press the **Preset Up/Down** button **13 43** or hold them pressed to scroll through the list of available PTY types, as shown above starting with the PTY currently received. To simply search for the next station transmitting any RDS data, use the **Preset Up/Down** button **13 43** until **RDS ONLY** appears in the display.
3. Press any of the **Tuning Up/Down** buttons **10 21**, the tuner begins to scan the FM band upwards or downwards for the first station that has RDS data that matches the desired selection, and acceptable signal strength for quality reception.

4. The tuner will make up to one complete scan of the entire FM band for the next station that matches the desired PTY type and has acceptable reception quality. If no such station is found, the display will read **NONE** for some seconds and the tuner will return to the last FM station in use before the search.

**NOTE:** Some stations transmit constant traffic information. These stations can be found by selecting **TRAFFIC**, the option in front of **NEWS** in the list. The AVR will find the next appropriate station, even if it is not broadcasting traffic information when the search is made.

## Programming the Remote

The AVR 147 is equipped with a powerful remote control that will control not only the receiver's functions, but also most popular brands of audio and video equipment, including CD players, TV sets, cable boxes, VCRs, satellite receivers and other home-theater equipment. Once the AVR's remote is programmed with the codes for the products you own, it is possible to eliminate most other remotes and replace them with the convenience of a single universal remote control.

### Programming the Remote with Codes

As shipped from the factory, the remote is fully programmed for all AVR functions, as well as those of most Harman Kardon CD changers, DVD players, CD players and cassette decks as well as the navigation controls for the Apple iPod. In addition, by following one of the methods below, you may program the remote to operate a wide range of devices from other manufacturers.

#### Direct Code Entry

This method is the easiest way to program your remote to work with different products.

1. Use the tables in the separate setup-code guide to determine the three-digit code or codes that match both the product type (e.g., VCR, TV), and the specific brand name. If there is more than one number for a brand, make note of the different choices.
2. Turn on the unit you wish to program into the AVR remote.
3. Press and hold the **Input Selector** **5** for the type of product to be entered (e.g., VCR, TV) for three seconds. When the **Program Indicator** **3** turns amber and begins flashing, release the button. It is important that you begin the next step within 20 seconds.
4. If the unit you wish to program into the AVR remote has a remotable Power on/off function, follow these steps:

- a. Point the AVR's remote towards the unit to be programmed, and enter the first three-digit code number using the **Numeric** buttons **18**. If the unit being programmed turns off, the correct code has been entered. Press the **Input Selector** **5** again, and note that the red light under the **Input Selector** will flash three times before going dark to confirm the entry.
- b. If the product to be programmed does NOT turn off, continue to enter the three-digit code numbers until the equipment turns off. At this point, the correct code has been entered. Press the **Input Selector** **5** again and note that the red light under the **Input Selector** will flash three times before going dark to confirm the entry.

5. If the Power function of the unit to be programmed cannot be remoted, follow these steps (max. 20 seconds after step 3 above, or else step 3 must be repeated first):

- a. Enter the first three-digit code number using the **Numeric** buttons **18** and press the **Input Selector** **5** again. Press the remote button of any transport function remotable with the unit, e.g. **Pause** or **Play** **▶** **26**. If the unit being programmed starts that function, the correct code has been entered.
  - b. If the unit does not start the function whose button was pressed, repeat steps 3 and 5a above with the next three-digit code number listed in the setup code table for that brand and product type, until the unit reacts properly on the transport function transmitted.
6. Try all of the functions on the remote to make certain that the product operates properly. Keep in mind that many manufacturers use a number of different combinations of codes, so it is a good idea to make certain that not only does the Power control work, but that the volume, channel and transport controls work as they should. If functions do not work properly, you may need to use a different remote code.
  7. If the unit does not react to any code entered, if the code for your product does not appear in the tables in the separate setup-code guide, or if not all functions operate properly, try programming the remote with the Auto Search Method.

#### Note on Using the AVR remote with a Harman Kardon CD Recorder.

As shipped from the factory, the remote is programmed for controlling Harman Kardon CD players. It can also control most functions of the Harman Kardon CD-Recorders (see function list on page 46-47) too after the code "002" is entered on the **CD Selector** button **5** as described above. For returning to the CD player control commands the code "001" must be entered.

#### Auto-Search Method

If the unit you wish to include in the AVR's remote is not listed in the code tables in the separate setup-code guide or if the code does not seem to operate properly, you may wish to program the correct code using the Auto Search method that follows. Note that the Auto Search method works only with units whose Power functions can be remoted:

1. Turn on the product that you wish to include in the AVR remote.
2. Press and hold the **Input Selector** **5** for the type of product to be entered (e.g., VCR, TV) for three seconds. When the **Program Indicator** **3** turns amber and begins flashing, release the button. It is important that you begin the next step within 20 seconds.

3. To find out if the code for your unit is pre-programmed, point the AVR remote towards the unit to be programmed, and press and hold the **▲** button **14**. This will send out a series of codes from the remote's built-in data base, with each flash of the red light under the **Input Selector** **5** indicating that a code has been sent. When the device to be programmed turns off, immediately release the **▲** button **14**. Note that it may take one minute or more until the right code is found and the unit turns off.

4. When the **▲** button was not released in time after the unit turned off, the proper code will be "overrun". That's why a function test should be made: Turn the unit on again and, while the **Input Selector** **5** still lights red, press the **▲** button **14** once, then the **▼** button **14** once too. When the unit turns off, the right code was found, when not, the code was "overrun". To re-find the correct, while the **Input Selector** **5** still lights red, press (not hold pressed) the **▼** button **14** repeatedly to step backwards through the codes available and observe the reaction of the unit at each press. As soon as the unit turns off the correct code is found.

5. Press the **Input Selector** **5** again, and note that the red light will flash three times before going dark to confirm the entry.

6. Try all of the functions on the remote to make certain that the product operates. Keep in mind that many manufacturers use a number of different combinations of codes, and it is a good idea to make certain that not only the Power control works, but the volume, channel and transport controls, as appropriate. If all functions do not work properly, you may need to Auto-Search for a different code, or enter a code via the Direct Code Entry method.

#### Code Readout

When the code has been entered using the Auto Search method, it is always a good idea to find out the exact code so that it may be easily reentered if necessary. You may also read the codes to verify which device has been programmed to a specific Control Selector button.

1. Press and hold the **Input Selector** **5** for the device you wish to find the code for for three seconds. Note that the **Program Indicator** **3** will initially turn amber and begin flashing. Release the button and begin the next step within 20 seconds.
2. Press the **Set** button **16**. The **Program Indicator** **3** will then blink green in a sequence that corresponds to the three-digit code, with a one-second pause between each digit. Count the number of blinks between each pause to determine the digit of the code. One blink is the number 1, two blinks is the number 2, and so forth. Note that a rapid sequence of three blinks is used to indicate a "0."

## Programming the Remote

Example: One blink, followed by a one-second pause, followed by six blinks, followed by a one-second pause, followed by four blinks indicates that the code has been set to 164.

For future reference enter the Setup Codes for the equipment in your system here:

DVD \_\_\_\_\_ CD \_\_\_\_\_

VID1/VCR \_\_\_\_\_ VID3/TV \_\_\_\_\_

VID2/CBL/SAT \_\_\_\_\_

TAPE \_\_\_\_\_

### Macro Programming

Macros enable you to easily repeat frequently used combinations of commands with the press of a single button on the AVR's remote control. Once programmed, a macro will send out up to 19 different remote codes in a pre-determined sequential order enabling you to automate the process of turning on your system, changing devices, or other common tasks. The AVR's remote can store up to five separate macro command sequences, one that is associated with the **Power On** button **4**, and four more that are accessed by pressing the **Macro** buttons **31**.

1. To start programming a macro, press the **Mute** button **39** and the **Macro** button **31** to be programmed or the **Power-On** button **4** at the same time. Note that the latest selected **Input Selector** will light red, and the **Program Indicator** **3** will flash amber.

2. Enter the steps for the macro sequence by pressing the button for the actual command step. Although the macro may contain up to 19 steps, each button press, including those used to change devices, counts as a step. The **Program Indicator** **3** will flash green twice to confirm each button press as you enter commands.

**NOTE:** While entering commands for Power On of any device during a macro sequence, press the **Mute** button **39**. DO NOT press the **Power ON** button **4**.

- Remember to press the appropriate **Input Selector** button **5** before functions are changed to another device. This is also needed for the **AVR Selector** button **6** itself, as long as it's not lit red and AVR functions shall be programmed.

3. When all the steps have been entered, press the **Sleep** button **10** to enter the commands. The red light under the **Input Selector** **5 6** will blink and then turn off and the **Program Indicator** **3** will flash green twice to confirm the macro to be programmed.

**Example:** To program the **Macro 1** **31** button so that it turns on the AVR, TV and a Sat-Receiver, follow these steps:

- Press the **Macro 1** button **31** and **Mute** **39** buttons at the same time and then release them.
- Note that the **Program Indicator** will flash amber.
- Press the **AVR Selector** **6**.
- Press the **Mute** **39** button to store the AVR's power on command.
- Press the **VID 2 Input Selector** button **5** to indicate the next command is for "TV".
- Press the **Mute** **39** button to store the TV Power On Command.
- Press the **VID 3 Input Selector** button **5** to indicate the next command is for "Sat-Receiver".
- Press the **Mute** **39** button to store the Sat-Receiver Power On command.
- Press the **Sleep/Channel Up** button **10** to complete the process and store the macro sequence.

After following these steps, each time you press the **Macro 1** button **31**, the remote will send all Power On commands.

### Erasing Macro Commands

To remove the commands that have been programmed into one of the Macro buttons, follow these steps:

- Press the **Mute** button **39** and the **Macro** button **31** that contains the commands you wish to erase.
- Note that the **Program Indicator** **3** will flash amber, and the red LED under the **Input Selector** **5 6** last used will turn on.
- Within ten seconds, press the **Surround Mode Selector/Channel Down** button **11**.
- The red LED under the **Selector** will go out, and the **Program Indicator** **3** will turn green and flash three times before it goes out.
- When the **Program Indicator** **3** goes out, the Macro has been erased.

### Programmed Device Functions

Once the AVR's remote has been programmed for the codes of other devices, press the appropriate **Input Selector** **5** to change the remote from control over the AVR to the additional product. When you press any of these buttons, it will briefly flash in red to indicate that you have changed the device being controlled.

When operating a device other than the AVR, the controls may not correspond exactly to the function printed on the remote or button. Some commands, such as the volume control, are the same as they are with the AVR. Other buttons will change their function so that they correspond to a secondary label on the remote. For example, the Sleep and Surround mode selector buttons also function as the Channel Up and Channel Down buttons when operating most TV sets, VCRs or Sat-Receivers.

For some products, however, the function of a particular button does not follow the command printed on the remote. In order to see which function a button controls, consult the Function List tables printed on page 46-47. To use those tables, first check the type of device being controlled (e.g., TV, VCR). Next, look at the remote control diagram on page 46. Note that each button has a number on it.

To find out what function a particular button has for a specific device, find the button number on the Function List and then look in the column for the device you are controlling. For example, button number 43 is the "Direct" button for the AVR, but it is the "Favorite" button for many cable television boxes and satellite receivers. Button number 29 is the Delay button for the AVR, but the Open/Close button for CD players.

Note that the numbers used to describe the button functions above and on page 46 for the purposes of describing how a button operates are a different set of numbers than those used in the rest of this manual to describe the button functions for the AVR.

### Notes on Using the AVR Remote With Other Devices.

- Manufacturers may use different code sets for the same product category. For that reason, it is important that you check to see if the code set you have entered operates as many controls as possible. If it appears that only a few functions operate, check to see if another code set will work with more buttons.
- Depending on the brand and product type used the functions listed in the Function List tables may not correspond with the function the unit reacts on the command. In these cases it's a good idea to edit the reaction of the unit into the corresponding line of the table or to set up a separate list.
- When a button is pressed on the AVR remote, the red light under the **Input Selector** **5 6** for the product being operated should flash briefly. If the Device Control Selector flashes for some but not all buttons for a particular product, it does NOT indicate a problem with the remote, but rather that no function is programmed for the button being pushed.

### Volume Punch-Through

The AVR's remote may be programmed to operate the **Volume Control** **40** and the **Mute** **39** from either the TV or the AVR in conjunction with any of the devices controlled by the remote. For example, since the AVR will likely be used as the sound system for TV viewing, you may wish to have the AVR's volume activated although the remote is set to run the TV. Either the AVR or TV volume control may be associated with any of the remote's devices.

## Programming the Remote

To program the remote for Volume Punch-Through, follow these steps:

1. Press and hold the **Input Selector** **5** for the unit you wish to have associated with the volume control until the red light illuminates under the **Input Selector** **5** and note that the **Program Indicator** **3** will flash amber.
2. Press the **Volume Up** button **40** and note that the **Program Indicator** **3** will stop flashing and stay amber.
3. Press either the **AVR Selector** **6** or the **Input Selector** **5**, depending on which system's volume control you wish to have attached for the punch-through mode. The **Program Indicator** **3** will blink green three times and then go out to confirm the data entry.

**Example:** To have the AVR's volume control activated even though the remote is set to control the TV, first press the **Video/TV Input Selector** **5** and the **Mute** button **39** at the same time. Next, press the **Volume Up** button **40**, followed by the **AVR Input Selector** **6**.

**NOTE:** Should you wish to return the remote to the original configuration after entering a Volume Punch-Through, you will need to repeat the steps shown above. However, press the same **Input Selector** in steps one and three.

### Channel Control Punch-Through

The AVR's remote may be programmed to operate so that the channel control function, performed with the **Sleep** **10** and **Surround** **11** buttons, for either the TV, cable or satellite receiver used in your system may be used in conjunction with one of the other devices controlled by the remote. For example, while using and controlling the VCR, you may wish to change channels on a cable box or satellite receiver without having to change the device selected by the AVR or the remote. To program the remote for Channel Control Punch-Through, follow these steps:

1. Press and hold the **Input Selector** button **5** for the device you wish to have the channel control associated with until the red light illuminates under the **Input Selector** **5** and the **Program Indicator** **3** flashes amber.
2. Press the **Volume Down** button **40**. The **Program Indicator** **3** will stop flashing and stay amber.

3. Press and release the **AVR** **6** or **Input Selector** button **5** for the device that will be used to change the channels. The **Program Indicator** **3** will blink green three times and then go out to confirm the data entry.

**Example:** To control the channels using your TV while the remote is set to control the VCR, first press the **VID 1/VCR Input Selector** button **5** and the **Mute** button **39** at the same time. Next, release them and press the **Volume Down** button **40**, followed by the same **Input Selector** button **5**.

**NOTE:** To remove the Channel Control Punch-Through and return the remote to its original configuration, repeat the steps shown in the example above. However, press the same **Input Selector** in Steps 1 and 3.

### Transport Control Punch-Through

The AVR's remote may be programmed to operate so that the **Transport Control Functions** **26** (Play, Stop, Fast Forward, Rewind, Pause and Record) for a VCR, DVD or CD will operate in conjunction with one of the other devices controlled by the remote. For example, while using and controlling the TV, you may wish to start or stop your VCR or DVD without having to change the device selected by the AVR or the remote. To program the remote for Transport Control Punch-Through, follow these steps:

1. Press and hold the **Input Selector** **5** for the device you wish to have the channel control associated until the red light illuminates, under the **Input Selector** **5** and the **Program Indicator** **3** flashes amber.
2. Press the **Play** button **26**. The **Program Indicator** **3** will stop flashing and stay amber.
3. Press and release the **AVR** **6** or **Input Selector** button **5** for the device that will be used to change the channels. The **Program Indicator** **3** will blink green three times and then go out to confirm the data entry.

**Example:** To control the transport of a CD player while the remote is set to control the TV, press the **VID 2/CBL/SAT Input Selector** button **5** and the **Mute** button **39** at the same time. Next, release them and press the **Play** button **26**, followed by the **CD Input Selector** button **5**.

**NOTE:** To remove the Channel Control Punch-Through and return the remote to its original configuration, repeat the steps shown in the example above. However, press the same **Input Selector** in Steps 1 and 3.

**NOTE:** Before programming the remote for Volume, Channel or Transport Punch-Through, make certain that any programming needed for the specific TV, CD, DVD, Cable or Satellite Receivers has been completed.

### Resetting the Remote Memory

As you add components to your home-theater system, occasionally you may wish to totally reprogram the remote control without the confusion of any commands, macros or "Punch-Through" programming that you may have done. To do this, it is possible to reset the remote to the original factory defaults and command codes by following these steps. Note, however, that once the remote is reset, all commands or codes that you have entered will be erased and will need to be re-entered:

1. Press any of the **Input Selector** buttons **5** and the **"0"** button **18** at the same time until the **Program Indicator** **3** begins to flash amber.
2. Press the **"3"** button **18** three times.
3. The red LED under the **Input Selector** **5** will go out and the **Program Indicator** **3** will stop flashing and turn green.
4. The **Program Indicator** **3** will remain green until the remote is reset. Note that this may take a while, depending on how many commands are in the memory and need to be erased.
5. When the **Program Indicator** **3** goes out, the remote has been reset to the factory settings.



# Function List

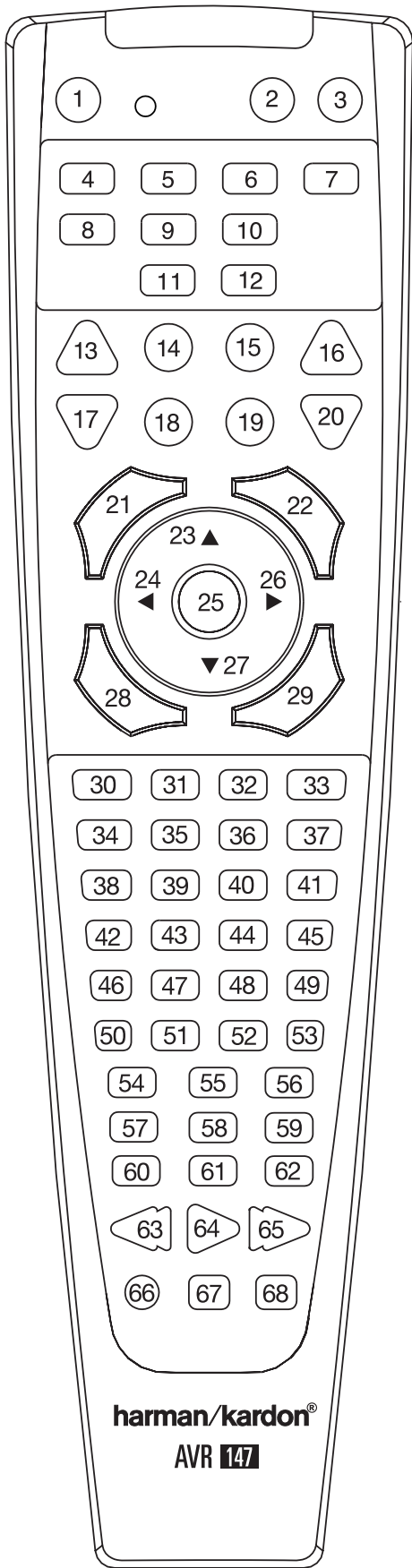

No.	Button Name	AVR Function	DVD	CD/CD-R	Tape
1	Power On	Power On	Power On	Power On	Power On
2	Power Off	Power Off	Power Off	Power Off	Power Off
3	Mute	Mute	Mute	Mute	Mute
4	AVR	AVR Select	AVR Select	AVR Select	AVR Select
5	DVD/ CD	DVD Input Select CD Input Select	DVD Input Select CD Input Select	DVD Input Select CD Input Select	DVD Input Select CD Input Select
6	Tape/ The Bridge	Tape Input Select The Bridge Input Select	Tape Input Select The Bridge Input Select	Tape Input Select The Bridge Input Select	Tape Input Select The Bridge Input Select
7	HDMI 1/ HDMI 2	HDMI 1 Input Select HDMI 2 Input Select	HDMI 1 Input Select HDMI 2 Input Select	HDMI 1 Input Select HDMI 2 Input Select	HDMI 1 Input Select HDMI 2 Input Select
8	VID 1 (VCR)	Video 1 Select	VCR Select	VCR Select	VCR Select
9	VID 2 (CBL/SAT)	Video 2 Select	CBL/SAT Select	CBL/SAT Select	CBL/SAT Select
10	VID 3 (TV)	Video 3 Select	TV Select	TV Select	TV Select
11	AM/FM	Tuner Select	Tuner Select	Tuner Select	Tuner Select
12	6 Ch. Select	6 Ch Input Select	6 Ch Input Select	6 Ch Input Select	6 Ch Input Select
13	Sleep/CH+	Sleep			
14	Test Tone	Test Tone			
15	T/V		TV/DVD or V. OFF	Input Select	
16	Volume Up	Volume Up	Volume Up	Volume Up	
17	Surround/CH-	DSP Surround Mode Select	Disc menu or Title	CDR Select	
18	OSD	OSD		Program	
19	Blank		HD Mode		
20	Volume Down	Volume Down	Volume Down	Volume Down	
21	Channel/Guide	Channel Trim	Title or Disc Menu	Continuous Play	
22	Speaker/Menu	Speaker Setup	Menu or Setup	Intro Scan	
23	▲	Move/Adjust Up	Up		
24	◀	Move/Adjust Left	Left		
25	Set	Set	Enter		
26	▶	Move/Adjust Right	Right		
27	▼	Move/Adjust Down	Down		
28	Digital/Exit	Digital Input Select	Open/Close		
29	Delay/Prev. Ch.	Delay Adjust	Return or Status	Open/Close	
30	1	1	1	1	1
31	2	2	2	2	2
32	3	3	3	3	3
33	4	4	4	4	4
34	5	5	5	5	5
35	6	6	6	6	6
36	7	7	7	7	7
37	8	8	8	8	8
38	Tun-M	Tuner Mode	Chapter+ or Zoom	Repeat	
39	9	9	9	9	9
40	0	0	0	0	0
41	Memory	Memory	Audio or Playlist	Time	
42	Tuning Up	Tuning Up	Next Chapter	Track Direct	
43	Direct	Direct Tuner Entry	Angle	Random Play	
44	Clear	Clear	Clear	Clear	
45	Preset Up	Preset Tune Up	Slow Forward	+10	
46	Tuning Down	Tune Down	Prev Chapter	Track Increment	
47	Tone	Tone Mode		Program	
48	RDS	RDS			
49	Preset Down	Preset Down	Slow Rev		
50	M1	Macro 1	Macro 1	Macro 1	Macro 1
51	M2	Macro 2	Macro 2	Macro 2	Macro 2
52	M3	Macro 3	Macro 3	Macro 3	Macro 3
53	M4	Macro 4	Macro 4	Macro 4	Macro 4
54	Dolby Surround	Dolby Modes			
55	DTS SURR	DTS Digital Modes			
56	DTS Neo:6	DTS Neo:6 Select			
57	Night	Night Mode Select	Subtitle On/Off	CDP Select	
58	Logic 7	Logic 7 Select			
59	Stereo	Stereo Mode Select			
60	Skip Down	Skip - (DVD)	Step -	Skip -	
61	Skip Up	Skip + (DVD)	Step +	Skip +	
62	Dim	Dimmer			
63	Rewind	R. Search (DVD)	R. Search	R. Search	Rewind
64	Play	Play (DVD)	Play	Play	R. Play/F. Play
65	Fast Forward	F. Search (DVD)	F. Search	F. Search	Fast Fwd
66	Record			Record	Record/Pause
67	Stop	Stop (DVD)	Stop	Stop	Stop
68	Pause	Pause (DVD)	Pause	Pause	

# Function List

No.	Button Name	VCR (VID 3)	TiVo (VID 1)	CBL (VID 2)	SAT (VID 2)	TV (VID 1)	<sup>TM</sup> Bridge (DMP)	HDMI 1/2
1	Power On		Power On	Power On	Power On	Power On	Power On	
2	Power Off	Power Off	Power Off	Power Off	Power Off	Power Off		
3	Mute	Mute	Mute	Mute	Mute	Mute		Mute
4	AVR	AVR Select	AVR Select	AVR Select	AVR Select	AVR Select	AVR Select	AVR Select
5	DVD CD	DVD Input Select CD Input Select	DVD Input Select CD Input Select	DVD Input Select CD Input Select	DVD Input Select CD Input Select	DVD Input Select CD Input Select	DVD Input Select CD Input Select	DVD Input Select CD Input Select
6	Tape/ <sup>TM</sup> Bridge	Tape Input Select The Bridge Input Select	Tape Input Select The Bridge Input Select	Tape Input Select The Bridge Input Select	Tape Input Select The Bridge Input Select	Tape Input Select The Bridge Input Select	Tape Input Select The Bridge Input Select	Tape Input Select The Bridge Input Select
7	HDMI 1/ HDMI 2	HDMI 1 Input Select HDMI 2 Input Select	HDMI 1 Input Select HDMI 2 Input Select	HDMI 1 Input Select HDMI 2 Input Select	HDMI 1 Input Select HDMI 2 Input Select	HDMI 1 Input Select HDMI 2 Input Select	HDMI 1 Input Select HDMI 2 Input Select	HDMI 1 Input Select HDMI 2 Input Select
8	VID 1 (VCR)	VCR Select	VCR Select	VCR Select	VCR Select	VCR Select	VCR Select	VCR Select
9	VID 2 (CBL/SAT)	CBL/SAT Select	CBL/SAT Select	CBL Select	SAT Select	CBL/SAT Select	CBL/SAT Select	CBL/SAT Select
10	VID 3 (TV)	TV Select	TV Select	TV Select	TV Select	TV Select	TV Select	TV Select
11	AM/FM	Tuner Select	Tuner Select	Tuner Select	Tuner Select	Tuner Select	Tuner Select	Tuner Select
12	6 Ch. Select	6 Ch Input Select	6 Ch Input Select	6 Ch Input Select	6 Ch Input Select	6 Ch Input Select	6 Ch Input Select	6 Ch Input Select
13	Sleep/CH+	Channel +	Channel +	Channel +	Channel +	Channel +		Channel +
14	Test Tone							
15	T/V	TV/VCR	TV Input	TV/CBL	TV/SAT	TV/VCR		TV/Video
16	Volume Up	Volume Up	Volume Up		Volume Up	Volume Up	Volume Up	
17	Surround/CH-	Channel -	Channel -	Channel -	Channel -	Channel -		Channel -
18	OSD	OSD	Live TV	OSD	OSD	OSD		OSD
19	Blank							
20	Volume Down	Volume Down	Volume Down		Volume Down	Volume Down	Volume Down	
21	Channel/Guide		Guide	Info/Guide	Info/Guide			Guide
22	Speaker/Menu	Menu	Menu	Menu	Menu	Menu	Menu	Menu
23	▲	Up	Up	Up	Up	Up		Up
24	◀	Left	Left	Left	Left	Left	Scroll -	Left
25	Set	Enter	Select	Enter	Enter	Enter	Select	Set/Enter
26	▶	Right	Right	Right	Right	Right	Scroll +	Right
27	▼	Down	Down	Down	Down	Down		Down
28	Digital/Exit		Return/Exit					
29	Delay/Prev. Ch.			Prev Channel	Prev Channel	Prev Channel		Prev Channel
30	1	1	1	1	1	1		1
31	2	2	2	2	2	2		2
32	3	3	3	3	3	3		3
33	4	4	4	4	4	4		4
34	5	5	5	5	5	5		5
35	6	6	6	6	6	6		6
36	7	7	7	7	7	7		7
37	8	8	8	8	8	8		8
38	Tun-M							
39	9	9	9	9	9	9		9
40	0	0	0	0	0	0		0
41	Memory							
42	Tune Up	Cancel			Cancel	Sleep		
43	Direct			FAV/Angle	FAV			FAV/Angle
44	Clear	Clear	Clear		Next			
45	Preset Up				Alt			
46	Tune Down							
47	Tone							
48	RDS							
49	Preset Down							
50	M1	Macro 1	Macro 1	Macro 1	Macro 1	Macro 1		Macro 1
51	M2	Macro 2	Macro 2	Macro 2	Macro 2	Macro 2		Macro 2
52	M3	Macro 3	Macro 3	Macro 3	Macro 3	Macro 3		Macro 3
53	M4	Macro 4	Macro 4	Macro 4	Macro 4	Macro 4		Macro 4
54	Dolby Surround							
55	DTS SURR							
56	DTS Neo:6							
57	Night							
58	Logic 7							
59	Stereo							
60	Skip Down	Scan -	Thumbs Down	Skip - (DVD)	Skip - (DVD)	Skip - (DVD)		
61	Skip Up	Scan +	Thumbs Up	Skip + (DVD)	Skip + (DVD)	Skip + (DVD)		
62	Dim							
63	Rewind	Rewind	R. Search	R. Search (DVD)	R. Search (DVD)	R. Search (DVD)	Skip - / R. Search	R. Search
64	Play	Play	Play	Play (DVD)	Play (DVD)	Play (DVD)	Play	Play
65	Fast Forward	Fast Fwd	F. Search	F. Search (DVD)	F. Search (DVD)	F. Search (DVD)	Skip + / F. Search	F. Search
66	Record	Record	Record					Record
67	Stop	Stop	Slow	Stop (DVD)	Stop (DVD)	Stop (DVD)		Stop
68	Pause	Pause	Pause	Pause (DVD)	Pause (DVD)	Pause (DVD)	Pause	Pause

# Troubleshooting Guide

SYMPTOM	CAUSE	SOLUTION
Unit does not function when <b>Main Power Switch 1</b> is pushed	<ul style="list-style-type: none"> <li>No AC Power</li> </ul>	<ul style="list-style-type: none"> <li>Make certain AC power cord is plugged into a live outlet</li> <li>Check to see if outlet is switch controlled</li> </ul>
Display lights, but no sound or picture	<ul style="list-style-type: none"> <li>Intermittent input connections</li> <li><b>Mute</b> is on</li> <li>Volume control is down</li> </ul>	<ul style="list-style-type: none"> <li>Make certain that all input and speaker connections are secure</li> <li>Press <b>Mute</b> button <b>49</b></li> <li>Turn up volume control</li> </ul>
No sound from any speaker; light around <b>Power switch 2</b> is red	<ul style="list-style-type: none"> <li>Amplifier is in protection mode due to possible short</li> <li>Amplifier is in protection mode due to internal problems</li> </ul>	<ul style="list-style-type: none"> <li>Check speaker-wire connections for shorts at receiver and speaker ends</li> <li>Contact your local Harman Kardon service depot</li> </ul>
No sound from surround or center speakers	<ul style="list-style-type: none"> <li>Incorrect surround mode</li> <li>Input is mono</li> <li>Incorrect configuration</li> <li>Stereo or Mono program material</li> </ul>	<ul style="list-style-type: none"> <li>Select a mode other than Stereo</li> <li>There is no surround information from mono sources (except with Theater and Hall surround modes)</li> <li>Check speaker mode configuration</li> <li>Some surround modes may not create rear-channel information from nonencoded programs</li> </ul>
Unit does not respond to remote commands	<ul style="list-style-type: none"> <li>Weak batteries in remote</li> <li>Wrong device selected</li> <li><b>Remote sensor 24</b> is obscured</li> </ul>	<ul style="list-style-type: none"> <li>Change remote batteries</li> <li>Press the <b>AVR Selector 6</b></li> <li>Make certain front-panel sensor is visible to remote or connect remote sensor</li> </ul>
Intermittent buzzing in tuner	<ul style="list-style-type: none"> <li>Local interference</li> </ul>	<ul style="list-style-type: none"> <li>Move unit or antenna away from computers, fluorescent lights, motors or other electrical appliances</li> </ul>
Letters flash in the <b>Channel Indicator Display 14</b> and Digital Audio stops	<ul style="list-style-type: none"> <li>Digital audio feed paused</li> </ul>	<ul style="list-style-type: none"> <li>Resume play for DVD</li> <li>Check that Digital Signal is fed to the Digital Input selected</li> </ul>

## Processor Reset

In the rare case where the unit's operation or the displays seem abnormal, the cause may involve the erratic operation of the system's memory or microprocessor.

To correct this problem, first unplug the unit from the AC wall outlet and wait at least three minutes. After the pause, reconnect the AC power cord and check the unit's operation. If the system still malfunctions, a system reset may clear the problem.

To clear the AVR's entire system memory including tuner presets, output level settings, delay times and speaker configuration data, first put the unit in Standby by pressing the **System Power Control** button **2**. Next press and hold the **Tone Mode** button **8** for three seconds.

The unit will turn on automatically. Note that once you have cleared the memory in this manner, it is necessary to re-establish all system configuration settings and tuner presets.

**NOTE:** Resetting the processor will erase any configuration settings you have made for speakers, output levels, surround modes, digital input assignments as well as the tuner presets. After a reset the unit will be returned to the factory presets, and all settings for these items must be reentered.

If the system is still operating incorrectly, there may have been an electronic discharge or severe AC line interference that has corrupted the memory or microprocessor.

If these steps do not solve the problem, consult an authorized Harman Kardon service depot.

# Technical Specifications

## Audio Section

Stereo Mode	
Continuous Average Power (FTC)	
50 Watts per channel, 20Hz–20kHz,	
@ < 0.07% THD, both channels driven into 8 ohms	
5 Channel Surround Modes	
Power Per Individual Channel	
Front L&R channels:	
40 Watts per channel,	
@ < 0.07% THD, 20Hz–20kHz into 8 ohms	
Center channel:	
40 Watts, @ < 0.07% THD, 20Hz–20kHz into 8 ohms	
Surround channels:	
40 Watts per channel,	
@ < 0.07% THD, 20Hz–20kHz into 8 ohms	
Input Sensitivity/Impedance	
Linear (High Level)	200mV/47kohms
Signal-to-Noise Ratio (IHF-A)	100dB
Surround System Adjacent Channel Separation	
Analog Decoding	40dB
(Pro Logic, etc.)	
Dolby Digital (AC-3)	55dB
DTS	55dB
Frequency Response	
@ 1W (+0dB, -3dB)	10Hz–130kHz
High Instantaneous	
Current Capability (HCC)	±25 Amps
Transient Intermodulation	
Distortion (TIM)	Unmeasurable
Rise Time	16 µsec
Slew Rate	40V/µsec**

## FM Tuner Section

Frequency Range	87.5–108MHz
Usable Sensitivity	IHF 1.3 µV/13.2dBf
Signal-to-Noise Ratio	Mono/Stereo: 70/68dB (DIN)
Distortion	Mono/Stereo: 0.2/0.3%
Stereo Separation	40dB @ 1kHz
Selectivity	±400kHz: 70dB
Image Rejection	80dB
IF Rejection	90dB

## AM Tuner Section

Frequency Range	522–1620kHz
Signal-to-Noise Ratio	45dB
Usable Sensitivity	Loop: 500µV
Distortion	1kHz, 50% Mod: 0.8%
Selectivity	±10kHz: 30dB

## Video Section

Video Format	PAL/NTSC
Input Level/Impedance	1Vp-p/75 ohms
Output Level/Impedance	1Vp-p/75 ohms
Video Frequency Response	
(Composite and S-Video)	10Hz–8MHz (-3dB)
Video Frequency	
Response (Component)	10Hz–100MHz (-3dB)
HDMI™	Switching

## General

Power Requirement	AC 220–240V/50Hz
Power Consumption	65W idle, 540W maximum (5 channels driven)
Dimensions (Max)	
Width	440mm
Height	165mm
Depth	382mm
Weight	9.7kg

Depth measurement includes knobs, buttons and terminal connections.  
Height measurement includes feet and chassis.

All features and specifications are subject to change without notice.

Harman Kardon, The Bridge  and Logic 7 are registered trademarks of Harman International Industries, Incorporated.

|||||EzSet/EQ™ is a trademark of Harman International Industries, Inc.

\*Manufactured under license from Dolby Laboratories.

"Dolby," "Pro Logic" and the Double-D symbol are trademarks of Dolby Laboratories.

"DTS" and "DTS Neo:6" are registered trademarks of DTS, Inc. "96/24" is a trademark of DTS, Inc.

SA-CD is a trademark of Sony Electronics, Inc.

Apple and iPod are registered trademarks of Apple Computer, Inc.

Cirrus is a registered trademark of Cirrus Logic Corp.

\*\*Without input anti slewing and output isolation networks.

HD-DVD is a trademark of the DVD Format/Logo Licensing Corporation (DVD FLLC).

HDMI, the HDMI logo and High-Definition Multimedia Interface are trademarks or registered trademarks of HDMI Licensing, LLC.



## APPENDIX – SETTINGS WORKSHEET

### Appendix – Default settings, worksheets, remote product codes

**Table A1 – Source Input Setting Defaults**

Source	DVD	HDMI 1	HDMI 2	Video 1	Video 2	Video 3	The Bridge/ DMP	CD	Tape	Tuner	6-Channel
Title										INT.TUNER	
Video Input	Comp V 1	HDMI 1	HDMI 2	Comp V 2	Comp V 3	Composite	The Bridge/ DMP	Comp V 1	Comp V 1	Comp V 1	Comp V 1
Audio Input	Coax 1	HDMI 1	HDMI 2	Analog	Optical 1	Analog	Analog (The Bridge/DMP)	Analog	Analog	Analog (Tuner)	Analog (6-Channel)
Auto Poll	On	Off	Off	On	On	On	Off	On	On	Off	Off
Surround Mode†	Logic 7 5CH Music	Logic 7 5CH Music	Logic 7 5CH Music	Logic 7 5CH Music	Logic 7 5CH Music	Logic 7 5CH Music	Logic 7 5CH Music	Logic 7 5CH Music	Logic 7 5CH Music	Logic 7 5CH Music	Logic 7 5CH Music

† The default shown is the preferred surround mode for PCM and Analog audio sources.

**Table A2 – Speaker/Channel Setting Defaults**

Source	DVD	HDMI 1	HDMI 2	Video 1	Video 2	Video 3	The Bridge /DMP	CD	Tape	Tuner	6-Channel
Bass Manager: Global											
Left/Right Speaker Size	Small	Small	Small	Small	Small	Small	Small	Small	Small	Small	Large
Center Speaker Size	Small	Small	Small	Small	Small	Small	Small	Small	Small	Small	Large
Surround Speaker Size	Small	Small	Small	Small	Small	Small	Small	Small	Small	Small	Large
Subwoofer	Sub	Sub	Sub	Sub	Sub	Sub	Sub	Sub	Sub	Sub	Sub
Left/Right Speaker Crossover	100Hz	100Hz	100Hz	100Hz	100Hz	100Hz	100Hz	100Hz	100Hz	100Hz	N/A
Center Speaker Crossover	100Hz	100Hz	100Hz	100Hz	100Hz	100Hz	100Hz	100Hz	100Hz	100Hz	N/A
Surround Speaker Crossover	100Hz	100Hz	100Hz	100Hz	100Hz	100Hz	100Hz	100Hz	100Hz	100Hz	N/A
Subwoofer Crossover	Left/Right	Left/Right	Left/Right	Left/Right	Left/Right	Left/Right	Left/Right	Left/Right	Left/Right	Left/Right	N/A

**Table A3 – Delay Setting Defaults**

Speaker Position	Distance From Speaker to Listening Position	Your Delay Settings
Front Left	3.0 meters	
Center	3.0 meters	
Front Right	3.0 meters	
Surround Right	3.0 meters	
Surround Left	3.0 meters	
Subwoofer	3.0 meters	
A/V Sync Delay	0mS	

## APPENDIX – SETTINGS WORKSHEET

**Table A4 – Source Input Settings**

Source	DVD	HDMI 1	HDMI 2	Video 1	Video 2	Video 3	The Bridge/DMP	CD	Tape	Tuner	6-Channel
Title											
Video Input											
Audio Input							The Bridge/DMP			Tuner	6-Channel
Auto Poll							---			---	---
Surround Mode											
Tone Mode											
Bass											
Treble											

**Table A5 – Speaker/Channel Settings**

Source	DVD	HDMI 1	HDMI 2	Video 1	Video 2	Video 3	The Bridge/DMP	CD	Tape	Tuner	6-Channel <sup>††</sup>
Left/Right Speaker Size											N/A
Center Speaker Size											N/A
Surround Speaker Size											N/A
Subwoofer											N/A
Left/Right Speaker Crossover											N/A
Center Speaker Crossover											N/A
Surround Speaker Crossover											N/A
Subwoofer Crossover											N/A
Left/Right Channel Level <sup>†††</sup>											
Center Channel Level <sup>†††</sup>											
Surround Channel Level <sup>†††</sup>											
Subwoofer Channel Level <sup>†††</sup>											

<sup>††</sup> The 6-Channel Inputs are "direct" inputs, meaning their signals are passed directly to the volume control without any bass management processing. Thus, the speaker sizes are always full range, and it isn't possible to adjust speaker size or crossover.  
<sup>†††</sup> Note: Channel levels vary by surround mode rather than source input.

**Table A6 – Remote Control Codes**

Source Input	Product Type (circle one or fill in)	Remote Control Code
Video 1	VCR, PVR	
Video 2	Cable, Satellite	
Video 3	TV	
DVD	DVD	
CD	CD, CDR	
Tape	Cassette	
HDMI 1	DVD, VCR, PVR, Cable, Satellite	
HDMI 2	DVD, VCR, PVR, Cable, Satellite	

**Table A7 – System Settings**

Feature	Default Setting	Your Setting
VFD Fade Time Out	Off	
Volume Default	Off	
Default Vol Set	-25dB	
Semi OSD Time Out	5 seconds	
Full OSD Time Out	20 seconds	
Default Surr Mode	On	

---

**harman/kardon®**



**H** A Harman International® Company  
250 Crossways Park Drive, Woodbury, New York 11797  
[www.harmankardon.com](http://www.harmankardon.com)  
Harman Consumer Group, Inc.:  
2, route de Tours, 72500 Château-du-Loir, France  
© 2007 Harman Kardon, Incorporated  
Part No.: OM P/N CQX1A1254Z